

# SKÄRRINGS- KOPPLINGAR

# 6



6

## HYDROSCAND SKÄRRINGSKOPPLINGAR

## PRODUKTGRUPP 600

Hydroscand skärringskopplingar används för rörledningar, t.ex. inom allmän maskinbyggnad, i huvudsak inom hydraulik och pneumatik. Hydroscand har även syrafasta skärringskopplingar för aggressiva media respektive omgivning. Arbetstryck / PN upp till 63 MPa / 630 Bar, för rör 4-42 mm diameter utvändigt. Tryckvärden enligt DIN 2353.

Skärringskopplingar kännetecknas av en mycket stabil rörfästning, stor motståndskraft mot vibrationer och tryckstötter. Kopplingarna kan demonteras/återmonteras ett flertal gånger.

Vid montering av skärningen pressas ringens två eggar in i röret och formar en mekanisk hållfunktion. Egg 1 har redan startat inträngningen innan egg 2 startar inskärningen i röret. Efter avslutat arbete trycks del 3 av ringen in mellan konan och röret så att inga vibrationer transporteras till skäreggarna. Del 4 säkrar radiell rörelse. Designen av ringprofilen medger en mycket stark axiell och radiell hållkraft. Påkänningar upptas av hela skärningens längd.

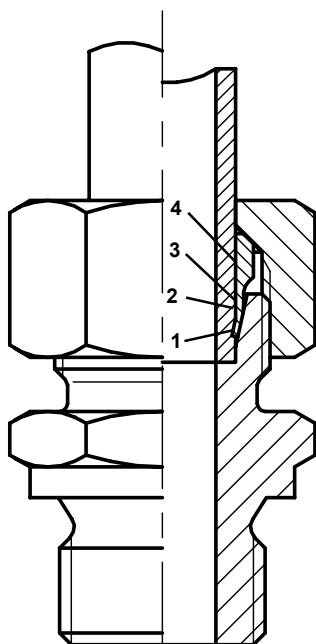

## MATERIAL

Hydroscands skärringskopplingar är tillverkade av automatstål eller från smidda ämnen. Standard för ytbehandlingen är E-coated. E-coated är namnet på den ytbehandling som vi använder på våra kopplingar. Ytbehandlingen är CR<sup>6</sup>-fri och därmed skonsammare för både hälsa och miljö.

Temperaturer upp till +200°C. Tätningsringar standard Perbuan upp till +90°C.

## ANSLUTNINGAR

Withworth rörgänga G, koniska rörgångor R, NPTF koniska, UNF, metrisk. Skärringskona enligt DIN W 3861 24° kona.

## GODKÄNNANDE

Hydroscand kan leverera kopplingar av bland annat följande normer/certifikat: DVGW, Norske Veritas, Germanischer Lloyd, ISO 9002.

## INNEHÅLL



## SKÄRRINGSKOPPLINGAR

## SIDA

|           |              |     |
|-----------|--------------|-----|
| 6003/6503 | GE - GB      | 310 |
| 6007/6507 | GE - NPT     | 311 |
| 6008/6508 | GE - UNF     | 312 |
| 6009/6509 | GE - G/ED    | 310 |
| 6010/6510 | GE - M/ED    | 311 |
| 6011/6511 | WE - R/C     | 312 |
| 6012/6512 | WEE - G      | 313 |
| 6013/6513 | WE - GB      | 312 |
| 6014/6514 | WE - MK/C    | 312 |
| 6016/6516 | WE - MB      | 313 |
| 6017/6517 | WE - NPT     | 313 |
| 6018/6518 | VEE - G      | 313 |
| 6021/6521 | TE - R/C     | 314 |
| 6022/6522 | TEE - GB     | 314 |
| 6023/6523 | TE - GB      | 314 |
| 6024      | TE - M       | 314 |
| 6025/6525 | TEE - M      | 314 |
| 6026/6526 | TEE - UNF    | 315 |
| 6027      | TE - NPT     | 314 |
| 6029/6529 | LEE - G      | 315 |
| 6030/6530 | LEE - M      | 316 |
| 6031/6531 | LE - R/C     | 315 |
| 6032/6532 | LEE - UNF    | 316 |
| 6033/6533 | LE - GB      | 315 |
| 6235      | DKLO - DKSO  | 316 |
| 6035/6535 | DKLO         | 316 |
| 6036      | LE - MB      | 315 |
| 6041/6541 | G            | 317 |
| 6042/6542 | W            | 317 |
| 6043/6543 | T            | 317 |
| 6044/6544 | K            | 317 |
| 6045/6545 | SV           | 318 |
| 6046/6546 | WSV          | 318 |
| 6047/6547 | AS           | 318 |
| 6048/6548 | ESV          | 318 |
| 6049/6549 | WAS          | 319 |
| 6051/6551 | EVWO         | 319 |
| 6055/6555 | EVO          | 321 |
| 6061/6561 | EVTO         | 319 |
| 6071/6571 | EVLO         | 319 |
| 6090/6590 | EVGEO - G/ED | 320 |
| 6092/6592 | EVGEO - M/ED | 320 |
| 6101/6601 | GAI - G      | 320 |
| 6102/6602 | GAI - M      | 320 |
| 6103/6603 | MAV - G      | 321 |
| 6105/6605 | RED          | 321 |
| 6109/6609 | KORO         | 322 |
| 6110/6610 | WHB - G      | 322 |
| 6111/6611 | WHB - M      | 323 |
| 6112/6612 | DSVW - G     | 323 |
| 6114/6614 | DSVT - G     | 324 |
| 6116/6616 | WHBT - G     | 324 |
| 6118/6618 | WHO - G      | 323 |
| 6119/6619 | WHO - M      | 323 |
| 6120/6620 | RHD          | 324 |
| 6121/6621 | RHV - G - ED | 325 |
| 6123/6623 | RHZ - G - ED | 325 |
| 6126      | RHR          | 325 |
| 6130/6630 | PL           | 325 |
| 6131/6631 | HOA          | 325 |





## SKÄRRINGSKOPPLINGAR

## SIDA

|           |                  |     |
|-----------|------------------|-----|
| 6149/6649 | D                | 326 |
| 6150/6650 | M                | 326 |
| 6151/6651 | FM               | 326 |
| 6152/6652 | D – ED B4        | 326 |
| 6153      | GM-låsmutter     | 327 |
| 6154-00   | ED-tätning NBR   | 327 |
| 6154-01   | ED-tätning Viton | 327 |
| 6160      | SN               | 327 |
| 6160-50   | O-ring för 6160  | 327 |
| 6171      | GE – R/C LL      | 308 |
| 6172      | GE – MK/C LL     | 308 |
| 6173      | WE – R/C LL      | 308 |
| 6174      | WE – MK/C LL     | 308 |
| 6175      | WE – NPT LL      | 308 |
| 6176      | G LL             | 309 |
| 6177      | GE – NPT LL      | 308 |
| 6178      | W LL             | 309 |
| 6179      | D LL – Skärning  | 309 |
| 6180      | M LL – Mutter    | 309 |
| 6181      | TE – MK/C LL     | 308 |
| 6182      | TE – R/C LL      | 308 |
| 6183      | LE – MK/C LL     | 309 |
| 6184      | LE – R/C LL      | 308 |
| 6185      | SWVE – M LL      | 309 |
| 6186      | SWVE – G LL      | 309 |
| 6187      | T LL             | 309 |
| 6188      | K LL             | 309 |
| 6189      | RED LL           | 309 |
| 6204/6704 | MAVO – EV G      | 321 |

TRYCKKLASSER FÖR SKÄRRINGSKOPPLINGAR

|      |      |      | LL  |   |   |   | L |   |    |    |    |    |    | S  |    |    |   |   |    |    |    |    |    |    |    |    |
|------|------|------|-----|---|---|---|---|---|----|----|----|----|----|----|----|----|---|---|----|----|----|----|----|----|----|----|
|      |      |      | 4   | 5 | 6 | 8 | 6 | 8 | 10 | 12 | 15 | 18 | 22 | 28 | 35 | 42 | 6 | 8 | 10 | 12 | 14 | 16 | 20 | 25 | 30 | 38 |
| 6001 | 6003 | 6031 |     |   |   |   |   |   |    |    |    |    |    |    |    |    |   |   |    |    |    |    |    |    |    |    |
| 6007 | 6008 | 6009 |     |   |   |   |   |   |    |    |    |    |    |    |    |    |   |   |    |    |    |    |    |    |    |    |
| 6010 | 6011 | 6013 |     |   |   |   |   |   |    |    |    |    |    |    |    |    |   |   |    |    |    |    |    |    |    |    |
| 6014 | 6016 | 6017 |     |   |   |   |   |   |    |    |    |    |    |    |    |    |   |   |    |    |    |    |    |    |    |    |
| 6021 | 6024 | 6027 |     |   |   |   |   |   |    |    |    |    |    |    |    |    |   |   |    |    |    |    |    |    |    |    |
| 6055 | 6035 | 6036 |     |   |   |   |   |   |    |    |    |    |    |    |    |    |   |   |    |    |    |    |    |    |    |    |
| 6041 | 6042 | 6043 |     |   |   |   |   |   |    |    |    |    |    |    |    |    |   |   |    |    |    |    |    |    |    |    |
| 6044 | 6045 | 6046 |     |   |   |   |   |   |    |    |    |    |    |    |    |    |   |   |    |    |    |    |    |    |    |    |
| 6047 | 6048 | 6049 | 100 |   |   |   |   |   |    |    |    |    |    |    |    |    |   |   |    |    |    |    |    |    |    |    |
| 6050 | 6051 | 6204 |     |   |   |   |   |   |    |    |    |    |    |    |    |    |   |   |    |    |    |    |    |    |    |    |
| 6061 | 6070 | 6071 |     |   |   |   |   |   |    |    |    |    |    |    |    |    |   |   |    |    |    |    |    |    |    |    |
| 6087 | 6089 | 6090 |     |   |   |   |   |   |    |    |    |    |    |    |    |    |   |   |    |    |    |    |    |    |    |    |
| 6092 | 6101 | 6102 |     |   |   |   |   |   |    |    |    |    |    |    |    |    |   |   |    |    |    |    |    |    |    |    |
| 6105 | 6107 | 6109 |     |   |   |   |   |   |    |    |    |    |    |    |    |    |   |   |    |    |    |    |    |    |    |    |
| 6130 | 6185 | 6216 |     |   |   |   |   |   |    |    |    |    |    |    |    |    |   |   |    |    |    |    |    |    |    |    |
| 6217 | 6218 | 6219 |     |   |   |   |   |   |    |    |    |    |    |    |    |    |   |   |    |    |    |    |    |    |    |    |
| 6537 | 6126 |      |     |   |   |   |   |   |    |    |    |    |    |    |    |    |   |   |    |    |    |    |    |    |    |    |
| 6088 | 6172 | 6171 |     |   |   |   |   |   |    |    |    |    |    |    |    |    |   |   |    |    |    |    |    |    |    |    |
| 6171 | 6173 | 6171 |     |   |   |   |   |   |    |    |    |    |    |    |    |    |   |   |    |    |    |    |    |    |    |    |
| 6175 | 6176 | 6177 | 100 |   |   |   |   |   |    |    |    |    |    |    |    |    |   |   |    |    |    |    |    |    |    |    |
| 6178 | 6181 | 6183 |     |   |   |   |   |   |    |    |    |    |    |    |    |    |   |   |    |    |    |    |    |    |    |    |
| 6184 | 6185 | 6186 |     |   |   |   |   |   |    |    |    |    |    |    |    |    |   |   |    |    |    |    |    |    |    |    |
| 6187 | 6188 | 3189 |     |   |   |   |   |   |    |    |    |    |    |    |    |    |   |   |    |    |    |    |    |    |    |    |
| 6110 | 6111 | 6116 |     |   |   |   |   |   |    |    |    |    |    |    |    |    |   |   |    |    |    |    |    |    |    |    |
| 6118 | 6119 |      |     |   |   |   |   |   |    |    |    |    |    |    |    |    |   |   |    |    |    |    |    |    |    |    |
| 6103 | 6104 |      |     |   |   |   |   |   |    |    |    |    |    |    |    |    |   |   |    |    |    |    |    |    |    |    |
| 6018 | 6012 | 6022 |     |   |   |   |   |   |    |    |    |    |    |    |    |    |   |   |    |    |    |    |    |    |    |    |
| 6029 |      |      |     |   |   |   |   |   |    |    |    |    |    |    |    |    |   |   |    |    |    |    |    |    |    |    |
| 6023 | 6033 |      |     |   |   |   |   |   |    |    |    |    |    |    |    |    |   |   |    |    |    |    |    |    |    |    |
| 6112 | 6114 |      |     |   |   |   |   |   |    |    |    |    |    |    |    |    |   |   |    |    |    |    |    |    |    |    |
| 6118 | 6119 |      | 100 |   |   |   |   |   |    |    |    |    |    |    |    |    |   |   |    |    |    |    |    |    |    |    |
| 6025 | 6030 |      |     |   |   |   |   |   |    |    |    |    |    |    |    |    |   |   |    |    |    |    |    |    |    |    |
| 6032 |      |      |     |   |   |   |   |   |    |    |    |    |    |    |    |    |   |   |    |    |    |    |    |    |    |    |
| 6120 | 6121 | 6123 |     |   |   |   |   |   |    |    |    |    |    |    |    |    |   |   |    |    |    |    |    |    |    |    |

\*) säkerhetsfaktor 1:3  
 \*\*) säkerhetsfaktor min 1,6

GÄNGOR

| Rördimension | Gänga      |
|--------------|------------|
| 4 LL         | M 8 x 1,0  |
| 4 LL         | M 10 x 1,0 |
| 6 LL         | M 10 x 1,0 |
| 8 LL         | M 12 x 1,0 |
| 6 L          | M 12 x 1,5 |
| 8 L          | M 14 x 1,5 |
| 10 L         | M 16 x 1,5 |
| 12 L         | M 18 x 1,5 |
| 15 L         | M 22 x 1,5 |
| 18 L         | M 26 x 1,5 |
| 22 L         | M 30 x 2,0 |
| 28 L         | M 36 x 2,0 |
| 35 L         | M 45 x 2,0 |
| 42 L         | M 52 x 2,0 |
| 6 S          | M 14 x 1,5 |
| 8 S          | M 16 x 1,5 |
| 10 S         | M 18 x 1,5 |
| 12 S         | M 20 x 1,5 |
| 14 S         | M 22 x 1,5 |
| 16 S         | M 24 x 1,5 |
| 20 S         | M 30 x 2,0 |
| 25 S         | M 36 x 2,0 |
| 30 S         | M 42 x 2,0 |
| 38 S         | M 52 x 2,0 |



## MONTERINGSANVISNING

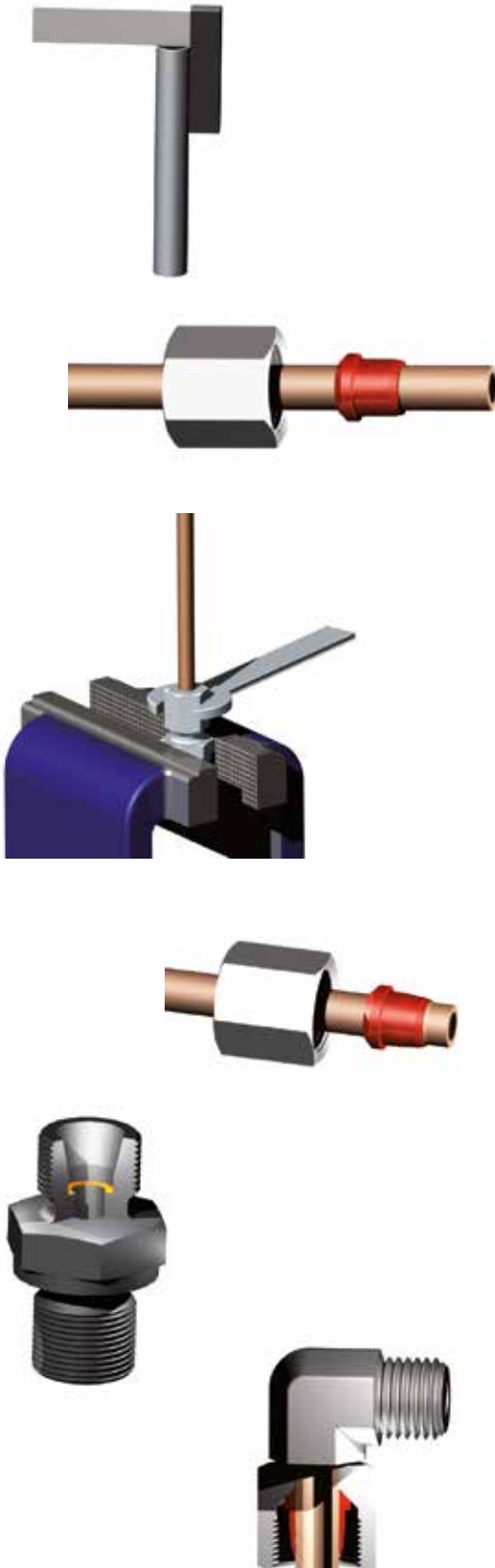

1. Kapa röret i 90°-vinkel (använd inte rullskärare av typen rörkapare), avlägsna alla grader in- och utvändigt.
2. Olja in 24°-konan, kopplingskroppen, skärningen samt muttern med därför avsedd olja. Till stålkopplingar används lämpligen vanlig mineralolja och till kopplingar i rostfritt eller syrafast material används Hydros cand specialolja art.nr. 5650-00-05
3. Placera muttern och skärningen på röret som bilden visar. Skärningens krage ska vara vänd mot muttern.
4. Håll röret mot röranslaget i kopplingen. Dra åt muttern tills man ej kan dra runt röret för hand.
5. Dra ytterligare 3/4 varv, röret får ej rotera. På detta sätt kommer kanten på muttern att skära in i den yttre delen av röret tillräckligt djupt och pressa upp en synlig vall medan den andra skärkanten tätar röret.
6. Lossa muttern och se till att det finns en tydlig vall runt hela röret. Vallen skall täcka 80% av skärningens främre kant. Denna kontroll är absolut nödvändig för allas säkerhet. Om vallen inte är tillräcklig måste förmonteringen göras om. Skärningen kan ofta efter montage fortfarande rotera på röret. Detta är normalt och påverkar ej tätheten.
7. Slutmontage.

Återmontera muttern på kopplingen för hand tills ett visst motstånd uppstår, dra sedan åt muttern ytterligare 1/4 varv.

**Slutmontering av förmonterade kopplingar**

Skruva åt muttern för hand så långt det går, dra därefter åt muttern ytterligare ca 1/2–3/4 varv. Efter detta är kopplingen klar att användas. Detta gäller för samtliga av våra förmonterade kopplingar.

**OBS!**

All förmontering av kopplingar i rostfritt stål måste utföras med ett förmonteringsverktyg (block eller maskin). Specialolja, artikelnr. 5650-00-05, skall användas för bästa resultat.

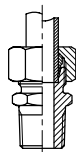

**6171**  
**GE – R/C LL**  
Rak koppling – R utv.  
Konisk tätning  
PRODUKTGRUPP 600

| Artikelnr. | Typ      | Rördim. | Gänga  |
|------------|----------|---------|--------|
| 6171-04-02 | GE 4 LL  | 4 mm    | R 1/8" |
| 6171-05-02 | GE 5 LL  | 5 mm    | R 1/8" |
| 6171-06-02 | GE 6 LL  | 6 mm    | R 1/8" |
| 6171-08-02 | GE 8 LL  | 8 mm    | R 1/8" |
| 6171-10-04 | GE 10 LL | 10 mm   | R 1/4" |
| 6171-12-04 | GE 12 LL | 12 mm   | R 1/4" |

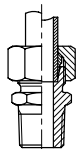

**6172**  
**GE – MK/C LL**  
Rak koppling – MK utv.  
Konisk tätning  
PRODUKTGRUPP 600

| Artikelnr. | Typ     | Rördim. | Gänga      |
|------------|---------|---------|------------|
| 6172-04-06 | GE 4 LL | 4 mm    | M 6 x 1 k  |
| 6172-04-08 | GE 4 LL | 4 mm    | M 8 x 1 k  |
| 6172-05-08 | GE 5 LL | 5 mm    | M 8 x 1 k  |
| 6172-06-06 | GE 6 LL | 6 mm    | M 6 x 1 k  |
| 6172-06-08 | GE 6 LL | 6 mm    | M 8 x 1 k  |
| 6172-06-10 | GE 6 LL | 6 mm    | M 10 x 1 k |
| 6172-08-08 | GE 8 LL | 8 mm    | M 8 x 1 k  |
| 6172-08-10 | GE 8 LL | 8 mm    | M 10 x 1 k |

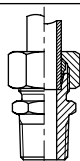

**6177**  
**GE – NPT LL**  
Rak koppling – NPT utv.  
Konisk tätning  
PRODUKTGRUPP 600

| Artikelnr. | Typ     | Rördim. | Gänga       |
|------------|---------|---------|-------------|
| 6177-04-02 | GE 4 LL | 4 mm    | 1/8"-27 NPT |
| 6177-05-02 | GE 5 LL | 5 mm    | 1/8"-27 NPT |
| 6177-06-02 | GE 6 LL | 6 mm    | 1/8"-27 NPT |
| 6177-08-02 | GE 8 LL | 8 mm    | 1/8"-27 NPT |

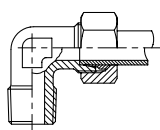

**6173**  
**WE – R/C LL**  
Vinkelkoppling – R utv.  
Konisk tätning  
PRODUKTGRUPP 600

| Artikelnr. | Typ      | Rördim. | Gänga  |
|------------|----------|---------|--------|
| 6173-04-02 | WE 4 LL  | 4 mm    | R 1/8" |
| 6173-05-02 | WE 5 LL  | 5 mm    | R 1/8" |
| 6173-06-02 | WE 6 LL  | 6 mm    | R 1/8" |
| 6173-08-02 | WE 8 LL  | 8 mm    | R 1/8" |
| 6173-10-04 | WE 10 LL | 10 mm   | R 1/4" |
| 6173-12-04 | WE 12 LL | 12 mm   | R 1/4" |

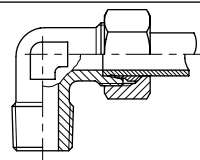

**6174**  
**WE – MK/C LL**  
90° vinkelkoppling – MK utv.  
Konisk tätning  
PRODUKTGRUPP 600

| Artikelnr. | Typ     | Rördim. | Gänga      |
|------------|---------|---------|------------|
| 6174-04-06 | WE 4 LL | 4 mm    | M 6 x 1 k  |
| 6174-04-08 | WE 4 LL | 4 mm    | M 8 x 1 k  |
| 6174-05-08 | WE 5 LL | 5 mm    | M 8 x 1 k  |
| 6174-06-06 | WE 6 LL | 6 mm    | M 6 x 1 k  |
| 6174-06-08 | WE 6 LL | 6 mm    | M 8 x 1 k  |
| 6174-06-10 | WE 6 LL | 6 mm    | M 10 x 1 k |
| 6174-08-10 | WE 8 LL | 8 mm    | M 10 x 1 k |

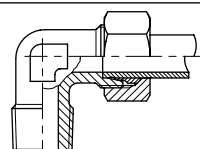

**6175**  
**WE – NPT LL**  
90° vinkelkoppling – NPT utv.  
Konisk tätning  
PRODUKTGRUPP 600

| Artikelnr. | Typ     | Rördim. | Gänga       |
|------------|---------|---------|-------------|
| 6175-04-02 | WE 4 LL | 4 mm    | 1/8"-27 NPT |
| 6175-05-02 | WE 5 LL | 5 mm    | 1/8"-27 NPT |
| 6175-06-02 | WE 6 LL | 6 mm    | 1/8"-27 NPT |
| 6175-08-02 | WE 8 LL | 8 mm    | 1/8"-27 NPT |

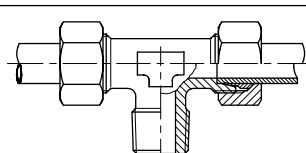

**6182**  
**TE – R/C LL**  
T-koppling – R utv.  
Konisk tätning  
PRODUKTGRUPP 600

| Artikelnr. | Typ     | Rördim. | Gänga  |
|------------|---------|---------|--------|
| 6182-04-02 | TE 4 LL | 4 mm    | R 1/8" |
| 6182-05-02 | TE 5 LL | 5 mm    | R 1/8" |
| 6182-06-02 | TE 6 LL | 6 mm    | R 1/8" |
| 6182-08-02 | TE 8 LL | 8 mm    | R 1/8" |

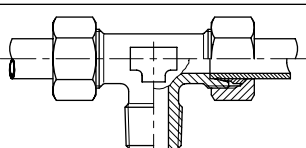

**6181**  
**TE – MK/C LL**  
T-koppling – MK utv.  
Konisk tätning  
PRODUKTGRUPP 600

| Artikelnr. | Typ     | Rördim. | Gänga     |
|------------|---------|---------|-----------|
| 6181-04-08 | TE 4 LL | 4 mm    | M8 x 1 k  |
| 6181-05-08 | TE 5 LL | 5 mm    | M8 x 1 k  |
| 6181-06-10 | TE 6 LL | 6 mm    | M10 x 1 k |
| 6181-08-10 | TE 8 LL | 8 mm    | M10 x 1 k |

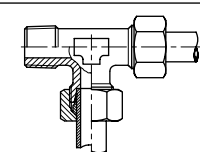

**6184**  
**LE – R/C LL**  
L-koppling – R utv.  
Konisk tätning  
PRODUKTGRUPP 600

| Artikelnr. | Typ     | Rördim. | Gänga  |
|------------|---------|---------|--------|
| 6184-04-02 | LE 4 LL | 4 mm    | R 1/8" |
| 6184-05-02 | LE 5 LL | 5 mm    | R 1/8" |
| 6184-06-02 | LE 6 LL | 6 mm    | R 1/8" |
| 6184-08-02 | LE 8 LL | 8 mm    | R 1/8" |

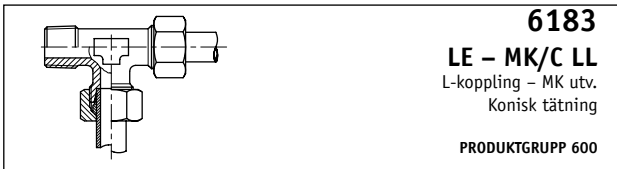

**6183**  
**LE – MK/C LL**  
L-koppling – MK utv.  
Konisk tätning  
PRODUKTGRUPP 600

| Artikelnr. | Typ     | Rördim. | Gänga     |
|------------|---------|---------|-----------|
| 6183-04-08 | LE 4 LL | 4 mm    | M8 x 1 k  |
| 6183-05-08 | LE 5 LL | 5 mm    | M8 x 1 k  |
| 6183-06-10 | LE 6 LL | 6 mm    | M10 x 1 k |
| 6183-08-10 | LE 8 LL | 8 mm    | M10 x 1 k |

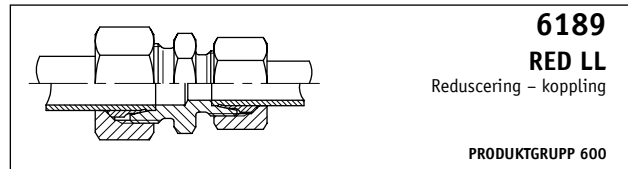

**6189**  
**RED LL**  
Reducering – koppling  
PRODUKTGRUPP 600

| Artikelnr. | Typ          | Rördim.  |
|------------|--------------|----------|
| 6189-06-04 | RED 6 / 4 LL | 6 - 4 mm |
| 6189-08-04 | RED 8 / 4 LL | 8 - 4 mm |
| 6189-08-06 | RED 8 / 6 LL | 8 - 6 mm |

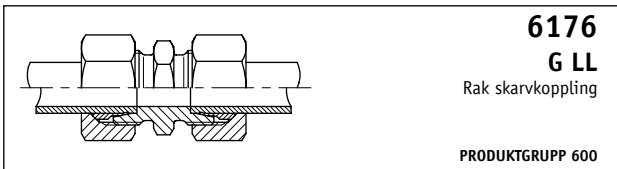

**6176**  
**G LL**  
Rak skarvkoppling  
PRODUKTGRUPP 600

| Artikelnr. | Typ     | Rördim. |
|------------|---------|---------|
| 6176-04-04 | G 4 LL  | 4 mm    |
| 6176-05-05 | G 5 LL  | 5 mm    |
| 6176-06-06 | G 6 LL  | 6 mm    |
| 6176-08-08 | G 8 LL  | 8 mm    |
| 6176-10-10 | G 10 LL | 10 mm   |
| 6176-12-12 | G 12 LL | 12 mm   |

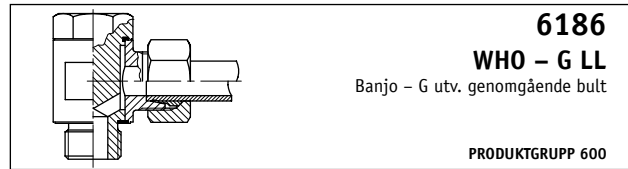

**6186**  
**WHO – G LL**  
Banjo – G utv. genomgående bult  
PRODUKTGRUPP 600

| Artikelnr. | Typ      | Rördim. | Gänga  |
|------------|----------|---------|--------|
| 6186-04-02 | WHO 4 LL | 4 mm    | G 1/8" |
| 6186-05-02 | WHO 5 LL | 5 mm    | G 1/8" |
| 6186-06-02 | WHO 6 LL | 6 mm    | G 1/8" |
| 6186-08-02 | WHO 8 LL | 8 mm    | G 1/8" |



**6178**  
**W LL**  
Vinkelskarvkoppling  
PRODUKTGRUPP 600

| Artikelnr. | Typ     | Rördim. |
|------------|---------|---------|
| 6178-04-04 | W 4 LL  | 4 mm    |
| 6178-05-05 | W 5 LL  | 5 mm    |
| 6178-06-06 | W 6 LL  | 6 mm    |
| 6178-08-08 | W 8 LL  | 8 mm    |
| 6178-10-10 | W 10 LL | 10 mm   |
| 6178-12-12 | W 12 LL | 12 mm   |

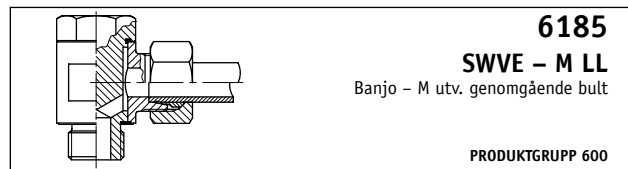

**6185**  
**SWVE – M LL**  
Banjo – M utv. genomgående bult  
PRODUKTGRUPP 600

| Artikelnr. | Typ       | Rördim. | Gänga      |
|------------|-----------|---------|------------|
| 6185-04-08 | SWVE 4 LL | 4 mm    | M 8 x 1.0  |
| 6185-05-08 | SWVE 5 LL | 6 mm    | M 8 x 1.0  |
| 6185-06-10 | SWVE 6 LL | 6 mm    | M 10 x 1.0 |
| 6185-08-10 | SWVE 8 LL | 8 mm    | M 10 x 1.0 |

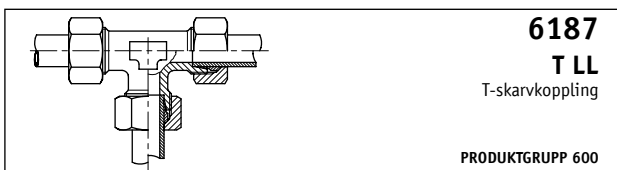

**6187**  
**T LL**  
T-skarvkoppling  
PRODUKTGRUPP 600

| Artikelnr. | Typ     | Rördim. |
|------------|---------|---------|
| 6187-04-04 | T 4 LL  | 4 mm    |
| 6187-05-05 | T 5 LL  | 5 mm    |
| 6187-06-06 | T 6 LL  | 6 mm    |
| 6187-08-08 | T 8 LL  | 8 mm    |
| 6187-10-10 | T 10 LL | 10 mm   |
| 6187-12-12 | T 12 LL | 12 mm   |



**6179**  
**D LL**  
Skärning  
PRODUKTGRUPP 600

| Artikelnr. | Typ     | Rördim. |
|------------|---------|---------|
| 6179-00-04 | D 4 LL  | 4 mm    |
| 6179-00-05 | D 5 LL  | 5 mm    |
| 6179-00-06 | D 6 LL  | 6 mm    |
| 6179-00-08 | D 8 LL  | 8 mm    |
| 6179-00-10 | D 10 LL | 10 mm   |
| 6179-00-12 | D 12 LL | 12 mm   |



**6188**  
**K LL**  
Korsskarvkoppling  
PRODUKTGRUPP 600

| Artikelnr. | Typ    | Rördim. |
|------------|--------|---------|
| 6188-04-04 | K 4 LL | 4 mm    |
| 6188-06-06 | K 6 LL | 6 mm    |
| 6188-08-08 | K 8 LL | 8 mm    |



**6180**  
**M LL**  
Mutter  
PRODUKTGRUPP 600

| Artikelnr. | Typ     | Rördim. | Gänga      |
|------------|---------|---------|------------|
| 6180-00-04 | M 4 LL  | 4 mm    | M 8 x 1.0  |
| 6180-00-05 | M 5 LL  | 5 mm    | M 10 x 1.0 |
| 6180-00-06 | M 6 LL  | 6 mm    | M 10 x 1.0 |
| 6180-00-08 | M 8 LL  | 8 mm    | M 14 x 1.0 |
| 6180-00-10 | M 10 LL | 10 mm   | M 10 x 1.0 |
| 6180-00-12 | M 12 LL | 12 mm   | M 16 x 1.0 |

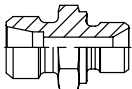

60° kona

**6003/6503**  
**GE-GB**  
Rak koppling - G utv.  
Kropp  
ISO 1179-4  
PRODUKTGRUPP 600



**6009/6509**  
**GE-G/ED**  
Rak koppling- G utv.  
Kropp  
ISO 1179-2  
PRODUKTGRUPP 600

| Artikelnr. | Typ     | Rördim. | Gänga    |
|------------|---------|---------|----------|
| 6003-06-03 | GE 6 L  | 6 mm    | G 1/8"   |
| 6003-06-05 | GE 6 L  | 6 mm    | G 1/4"   |
| 6003-06-07 | GE 6 L  | 6 mm    | G 3/8"   |
| 6003-08-03 | GE 8 L  | 8 mm    | G 1/8"   |
| 6003-08-05 | GE 8 L  | 8 mm    | G 1/4"   |
| 6003-08-07 | GE 8 L  | 8 mm    | G 3/8"   |
| 6003-08-09 | GE 8 L  | 8 mm    | G 1/2"   |
| 6003-10-03 | GE 10 L | 8 mm    | G 1/8"   |
| 6003-10-05 | GE 10 L | 10 mm   | G 1/4"   |
| 6003-10-07 | GE 10 L | 10 mm   | G 3/8"   |
| 6003-10-09 | GE 10 L | 10 mm   | G 1/2"   |
| 6003-12-05 | GE 12 L | 12 mm   | G 1/4"   |
| 6003-12-07 | GE 12 L | 12 mm   | G 3/8"   |
| 6003-12-09 | GE 12 L | 12 mm   | G 1/2"   |
| 6003-15-07 | GE 15 L | 15 mm   | G 3/8"   |
| 6003-15-09 | GE 15 L | 15 mm   | G 1/2"   |
| 6003-15-13 | GE 15 L | 15 mm   | G 3/4"   |
| 6003-18-07 | GE 18 L | 18 mm   | G 3/8"   |
| 6003-18-09 | GE 18 L | 18 mm   | G 1/2"   |
| 6003-18-13 | GE 18 L | 18 mm   | G 3/4"   |
| 6003-22-09 | GE 22 L | 22 mm   | G 1/2"   |
| 6003-22-13 | GE 22 L | 22 mm   | G 3/4"   |
| 6003-22-17 | GE 22 L | 22 mm   | G 1"     |
| 6003-28-13 | GE 28 L | 28 mm   | G 3/4"   |
| 6003-28-17 | GE 28 L | 28 mm   | G 1"     |
| 6003-35-17 | GE 35 L | 35 mm   | G 1"     |
| 6003-35-21 | GE 35 L | 35 mm   | G 1 1/4" |
| 6003-42-21 | GE 42 L | 42 mm   | G 1 1/4" |
| 6003-42-25 | GE 42 L | 42 mm   | G 1 1/2" |
| 6503-06-05 | GE 6 S  | 6 mm    | G 1/4"   |
| 6503-08-05 | GE 8 S  | 8 mm    | G 1/4"   |
| 6503-08-07 | GE 8 S  | 8 mm    | G 3/8"   |
| 6503-10-05 | GE 10 S | 10 mm   | G 1/4"   |
| 6503-10-07 | GE 10 S | 10 mm   | G 3/8"   |
| 6503-10-09 | GE 10 S | 10 mm   | G 1/2"   |
| 6503-12-05 | GE 12 S | 12 mm   | G 1/4"   |
| 6503-12-07 | GE 12 S | 12 mm   | G 3/8"   |
| 6503-12-09 | GE 12 S | 12 mm   | G 1/2"   |
| 6503-14-07 | GE 14 S | 14 mm   | G 3/8"   |
| 6503-14-09 | GE 14 S | 14 mm   | G 1/2"   |
| 6503-16-07 | GE 16 S | 16 mm   | G 3/8"   |
| 6503-16-09 | GE 16 S | 16 mm   | G 1/2"   |
| 6503-16-13 | GE 16 S | 16 mm   | G 3/4"   |
| 6503-20-09 | GE 20 S | 20 mm   | G 1/2"   |
| 6503-20-13 | GE 20 S | 20 mm   | G 3/4"   |
| 6503-20-17 | GE 20 S | 20 mm   | G 1"     |
| 6503-25-13 | GE 25 S | 25 mm   | G 3/4"   |
| 6503-25-17 | GE 25 S | 25 mm   | G 1"     |
| 6503-30-17 | GE 30 S | 30 mm   | G 1"     |
| 6503-30-21 | GE 30 S | 30 mm   | G 1 1/4" |
| 6503-38-17 | GE 38 S | 38 mm   | G 1"     |
| 6503-38-21 | GE 38 S | 38 mm   | G 1 1/4" |
| 6503-38-25 | GE 38 S | 38 mm   | G 1 1/2" |

| Artikelnr. | Typ     | Rördim. | Gänga    |
|------------|---------|---------|----------|
| 6009-06-03 | GE 6 L  | 6 mm    | G 1/8"   |
| 6009-06-05 | GE 6 L  | 6 mm    | G 1/4"   |
| 6009-08-03 | GE 8 L  | 8 mm    | G 1/8"   |
| 6009-08-05 | GE 8 L  | 8 mm    | G 1/4"   |
| 6009-08-07 | GE 8 L  | 8 mm    | G 3/8"   |
| 6009-08-09 | GE 8 L  | 8 mm    | G 1/2"   |
| 6009-10-03 | GE 10 L | 10 mm   | G 1/8"   |
| 6009-10-05 | GE 10 L | 10 mm   | G 1/4"   |
| 6009-10-07 | GE 10 L | 10 mm   | G 3/8"   |
| 6009-10-09 | GE 10 L | 10 mm   | G 1/2"   |
| 6009-12-05 | GE 12 L | 12 mm   | G 1/4"   |
| 6009-12-07 | GE 12 L | 12 mm   | G 3/8"   |
| 6009-12-09 | GE 12 L | 12 mm   | G 1/2"   |
| 6009-15-07 | GE 15 L | 15 mm   | G 3/8"   |
| 6009-15-09 | GE 15 L | 15 mm   | G 1/2"   |
| 6009-15-13 | GE 15 L | 15 mm   | G 3/4"   |
| 6009-18-07 | GE 18 L | 18 mm   | G 3/8"   |
| 6009-18-09 | GE 18 L | 18 mm   | G 1/2"   |
| 6009-18-13 | GE 18 L | 18 mm   | G 3/4"   |
| 6009-22-09 | GE 22 L | 22 mm   | G 1/2"   |
| 6009-22-13 | GE 22 L | 22 mm   | G 3/4"   |
| 6009-22-17 | GE 22 L | 22 mm   | G 1"     |
| 6009-28-13 | GE 28 L | 28 mm   | G 3/4"   |
| 6009-28-17 | GE 28 L | 28 mm   | G 1"     |
| 6009-28-21 | GE 28 L | 28 mm   | G 1 1/4" |
| 6009-35-17 | GE 35 L | 35 mm   | G 1"     |
| 6009-35-21 | GE 35 L | 35 mm   | G 1 1/4" |
| 6009-42-21 | GE 42 L | 42 mm   | G 1 1/4" |
| 6009-42-25 | GE 42 L | 42 mm   | G 1 1/2" |
| 6509-06-05 | GE 6 S  | 6 mm    | G 1/4"   |
| 6509-08-05 | GE 8 S  | 8 mm    | G 1/4"   |
| 6509-08-07 | GE 8 S  | 8 mm    | G 3/8"   |
| 6509-08-09 | GE 8 S  | 8 mm    | G 1/2"   |
| 6509-10-05 | GE 10 S | 10 mm   | G 1/4"   |
| 6509-10-07 | GE 10 S | 10 mm   | G 3/8"   |
| 6509-12-05 | GE 12 S | 12 mm   | G 1/4"   |
| 6509-12-07 | GE 12 S | 12 mm   | G 3/8"   |
| 6509-12-09 | GE 12 S | 12 mm   | G 1/2"   |
| 6509-14-09 | GE 14 S | 14 mm   | G 1/2"   |
| 6509-16-07 | GE 16 S | 16 mm   | G 3/8"   |
| 6509-16-09 | GE 16 S | 16 mm   | G 1/2"   |
| 6509-16-13 | GE 16 S | 16 mm   | G 3/4"   |
| 6509-20-09 | GE 20 S | 20 mm   | G 1/2"   |
| 6509-20-13 | GE 20 S | 20 mm   | G 3/4"   |
| 6509-20-17 | GE 20 S | 20 mm   | G 1"     |
| 6509-25-09 | GE 25 S | 25 mm   | G 1/2"   |
| 6509-25-13 | GE 25 S | 25 mm   | G 3/4"   |
| 6509-25-17 | GE 25 S | 25 mm   | G 1"     |
| 6509-30-17 | GE 30 S | 30 mm   | G 1"     |
| 6509-30-21 | GE 30 S | 30 mm   | G 1 1/4" |
| 6509-38-21 | GE 38 S | 38 mm   | G 1 1/4" |
| 6509-38-25 | GE 38 S | 38 mm   | G 1 1/2" |

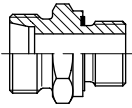

**6010/6510****GE-M/ED**

Rak koppling – M utv.  
Kropp  
ISO 9974-2  
PRODUKTGRUPP 600

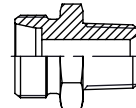
**6007/6507****GE-NPT**

Rak koppling – NPT utv.  
Kropp  
ANSI/ASME B1.20.1-1983  
PRODUKTGRUPP 600

| Artikelnr. | Typ     | Rördim. | Gänga      |
|------------|---------|---------|------------|
| 6010-06-11 | GE 6 L  | 6 mm    | M 10 x 1.0 |
| 6010-08-13 | GE 8 L  | 8 mm    | M 12 x 1.5 |
| 6010-10-15 | GE 10 L | 10 mm   | M 14 x 1.5 |
| 6010-10-17 | GE 10 L | 10 mm   | M 16 x 1.5 |
| 6010-12-15 | GE 12 L | 12 mm   | M 14 x 1.5 |
| 6010-12-17 | GE 12 L | 12 mm   | M 16 x 1.5 |
| 6010-12-19 | GE 12 L | 12 mm   | M 18 x 1.5 |
| 6010-12-23 | GE 12 L | 12 mm   | M 22 x 1.5 |
| 6010-15-19 | GE 15 L | 15 mm   | M 18 x 1.5 |
| 6010-15-23 | GE 15 L | 15 mm   | M 22 x 1.5 |
| 6010-18-23 | GE 18 L | 18 mm   | M 22 x 1.5 |
| 6010-22-27 | GE 22 L | 22 mm   | M 26 x 1.5 |
| 6010-28-34 | GE 28 L | 28 mm   | M 33 x 2.0 |
| 6010-35-43 | GE 35 L | 35 mm   | M 42 x 2.0 |
| 6010-42-49 | GE 42 L | 42 mm   | M 48 x 2.0 |
| 6510-06-13 | GE 6 S  | 6 mm    | M 12 x 1.5 |
| 6510-08-15 | GE 8 S  | 8 mm    | M 14 x 1.5 |
| 6510-10-17 | GE 10 S | 10 mm   | M 16 x 1.5 |
| 6510-12-19 | GE 12 S | 12 mm   | M 18 x 1.5 |
| 6510-14-21 | GE 14 S | 14 mm   | M 20 x 1.5 |
| 6510-16-23 | GE 16 S | 16 mm   | M 22 x 1.5 |
| 6510-20-23 | GE 20 S | 20 mm   | M 22 x 1.5 |
| 6510-20-28 | GE 20 S | 20 mm   | M 27 x 2.0 |
| 6510-25-34 | GE 25 S | 25 mm   | M 33 x 2.0 |
| 6510-30-43 | GE 30 S | 30 mm   | M 42 x 2.0 |
| 6510-38-49 | GE 38 S | 38 mm   | M 48 x 2.0 |

| Artikelnr. | Typ     | Rördim. | Gänga          |
|------------|---------|---------|----------------|
| 6007-06-03 | GE 6 L  | 6 mm    | 1/8"-27 NPT    |
| 6007-06-05 | GE 6 L  | 6 mm    | 1/4"-18 NPT    |
| 6007-06-07 | GE 6 L  | 6 mm    | 3/8"-18 NPT    |
| 6007-08-03 | GE 8 L  | 8 mm    | 1/8"-27 NPT    |
| 6007-08-05 | GE 8 L  | 8 mm    | 1/4"-18 NPT    |
| 6007-10-05 | GE 10 L | 10 mm   | 1/4"-18 NPT    |
| 6007-10-07 | GE 10 L | 10 mm   | 3/8"-18 NPT    |
| 6007-12-05 | GE 12 L | 12 mm   | 1/4"-18 NPT    |
| 6007-12-07 | GE 12 L | 12 mm   | 3/8"-18 NPT    |
| 6007-12-09 | GE 12 L | 12 mm   | 1/2"-14 NPT    |
| 6007-15-07 | GE 15 L | 15 mm   | 3/8" 18 NPT    |
| 6007-15-09 | GE 15 L | 15 mm   | 1/2"-14 NPT    |
| 6007-15-13 | GE 15 L | 15 mm   | 3/4"-14 NPT    |
| 6007-18-09 | GE 18 L | 18 mm   | 1/2"-14 NPT    |
| 6007-22-09 | GE 22 L | 22 mm   | 1/2"-14 NPT    |
| 6007-22-13 | GE 22 L | 22 mm   | 3/4"-14 NPT    |
| 6007-28-17 | GE 28 L | 28 mm   | 1"-11½ NPT     |
| 6007-35-21 | GE 35 L | 35 mm   | 1 1/4"-11½ NPT |
| 6007-42-25 | GE 42 L | 42 mm   | 1 1/2"-11½ NPT |
| 6507-06-05 | GE 6 S  | 6 mm    | 1/4"-18 NPT    |
| 6507-08-05 | GE 8 S  | 8 mm    | 1/4"-18 NPT    |
| 6507-10-05 | GE 10 S | 10 mm   | 1/4"-18 NPT    |
| 6507-10-07 | GE 10 S | 10 mm   | 3/8"-18 NPT    |
| 6507-12-05 | GE 12 S | 12 mm   | 1/4"-18 NPT    |
| 6507-12-07 | GE 12 S | 12 mm   | 3/8"-18 NPT    |
| 6507-12-09 | GE 12 S | 12 mm   | 1/2"-14 NPT    |
| 6507-12-13 | GE 12 S | 12 mm   | 3/4" 14 NPT    |
| 6507-14-09 | GE 14 S | 14 mm   | 1/2"-14 NPT    |
| 6507-16-09 | GE 16 S | 16 mm   | 1/2"-14 NPT    |
| 6507-20-09 | GE 20 S | 20 mm   | 1/2"-14 NPT    |
| 6507-20-13 | GE 20 S | 20 mm   | 3/4"-14 NPT    |
| 6507-25-17 | GE 25 S | 25 mm   | 1"-11½ NPT     |
| 6507-30-21 | GE 30 S | 30 mm   | 1 1/4"-11½ NPT |
| 6507-38-25 | GE 38 S | 38 mm   | 1 1/2"-11½ NPT |

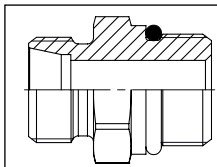

**6008/6508**

**GE – UNF**

Rak koppling – UNF utv.  
Kropp  
UN-UNF SAE J514  
PRODUKTGRUPP 600

| Artikelnr.  | Typ     | Rördim. | Gänga         |
|-------------|---------|---------|---------------|
| 6008-06-079 | GE 6 L  | 6 mm    | 7/16"-20 UNF  |
| 6008-08-079 | GE 8 L  | 8 mm    | 7/16"-20 UNF  |
| 6008-08-089 | GE 8 L  | 8 mm    | 1/2"-20 UNF   |
| 6008-10-079 | GE 10 L | 10 mm   | 7/16"-20 UNF  |
| 6008-10-10  | GE 10 L | 10 mm   | 9/16"-18 UNF  |
| 6008-12-10  | GE 12 L | 12 mm   | 9/16"-18 UNF  |
| 6008-12-13  | GE 12 L | 12 mm   | 3/4"-16 UNF   |
| 6008-12-15  | GE 12 L | 12 mm   | 7/8"-14 UNF   |
| 6008-15-13  | GE 15 L | 15 mm   | 3/4"-16 UNF   |
| 6008-15-15  | GE 15 L | 15 mm   | 7/8"-14 UNF   |
| 6008-18-13  | GE 18 L | 18 mm   | 3/4"-16 UNF   |
| 6008-18-15  | GE 18 L | 18 mm   | 7/8"-14 UNF   |
| 6008-22-15  | GE 22 L | 22 mm   | 7/8"-14 UNF   |
| 6008-22-18  | GE 22 L | 22 mm   | 1 1/16"-12 UN |
| 6008-22-22  | GE 22 L | 22 mm   | 1 5/16"-12 UN |
| 6008-28-18  | GE 28 L | 28 mm   | 1 1/16"-12 UN |
| 6008-28-22  | GE 28 L | 28 mm   | 1 5/16"-12 UN |
| 6008-35-22  | GE 35 L | 35 mm   | 1 5/16"-12 UN |
| 6008-35-27  | GE 35 L | 35 mm   | 1 5/8"-12 UN  |
| 6008-42-27  | GE 42 L | 42 mm   | 1 5/8"-12 UN  |
| 6008-42-31  | GE 42 L | 42 mm   | 1 7/8"-12 UN  |
| 6508-08-079 | GE 8 S  | 8 mm    | 7/16"-20 UNF  |
| 6508-08-089 | GE 8 S  | 8 mm    | 1/2"-20 UNF   |
| 6508-10-10  | GE 10 S | 10 mm   | 9/16"-18 UNF  |
| 6508-12-10  | GE 12 S | 12 mm   | 9/16"-18 UNF  |
| 6508-12-13  | GE 12 S | 12 mm   | 3/4"-16 UNF   |
| 6508-16-13  | GE 16 S | 16 mm   | 3/4"-16 UNF   |
| 6508-16-15  | GE 16 S | 16 mm   | 7/8"-14 UNF   |
| 6508-20-13  | GE 20 S | 20 mm   | 3/4"-16 UNF   |
| 6508-20-15  | GE 20 S | 20 mm   | 7/8"-14 UNF   |
| 6508-20-18  | GE 20 S | 20 mm   | 1 1/16"-12 UN |
| 6508-25-18  | GE 25 S | 25 mm   | 1 1/16"-12 UN |
| 6508-25-22  | GE 25 S | 25 mm   | 1 5/16"-12 UN |
| 6508-30-22  | GE 30 S | 30 mm   | 1 5/16"-12 UN |
| 6508-38-27  | GE 38 S | 38 mm   | 1 5/8"-12 UN  |
| 6508-38-31  | GE 38 S | 38 mm   | 1 7/8"-12 UN  |

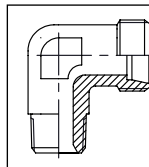

**6011/6511**

**WE-R/C**

90° vinkelkoppling – R utv.  
Kropp  
C DIN 3852  
PRODUKTGRUPP 600

| Artikelnr. | Typ     | Rördim. | Gänga  |
|------------|---------|---------|--------|
| 6011-06-03 | WE 6 L  | 6 mm    | R 1/8" |
| 6011-06-05 | WE 6 L  | 6 mm    | R 1/4" |
| 6011-08-03 | WE 8 L  | 8 mm    | R 1/8" |
| 6011-08-05 | WE 8 L  | 8 mm    | R 1/4" |
| 6011-08-07 | WE 8 L  | 8 mm    | R 3/8" |
| 6011-10-05 | WE 10 L | 10 mm   | R 1/4" |
| 6011-10-07 | WE 10 L | 10 mm   | R 3/8" |
| 6011-12-05 | WE 12 L | 12 mm   | R 1/4" |
| 6011-12-07 | WE 12 L | 12 mm   | R 3/8" |
| 6011-12-09 | WE 12 L | 12 mm   | R 1/2" |
| 6011-15-07 | WE 15 L | 15 mm   | R 3/8" |
| 6011-15-09 | WE 15 L | 15 mm   | R 1/2" |
| 6011-18-09 | WE 18 L | 18 mm   | R 1/2" |
| 6011-18-13 | WE 18 L | 18 mm   | R 3/4" |
| 6011-22-13 | WE 22 L | 20 mm   | R 3/4" |
| 6511-06-05 | WE 6 S  | 6 mm    | R 1/4" |
| 6511-08-05 | WE 8 S  | 8 mm    | R 1/4" |
| 6511-10-07 | WE 10 S | 10 mm   | R 3/8" |
| 6511-12-07 | WE 12 S | 12 mm   | R 3/8" |
| 6511-14-07 | WE 14 S | 14 mm   | R 3/8" |
| 6511-14-09 | WE 14 S | 14 mm   | R 1/2" |
| 6511-16-09 | WE 16 S | 16 mm   | R 1/2" |
| 6511-20-13 | WE 20 S | 20 mm   | R 3/4" |

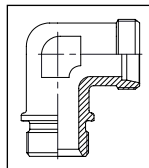

**6013/6513**

**WE-GB**

90° vinkelkoppling – G utv.  
Kropp  
PRODUKTGRUPP 600  
B DIN 3852

| Artikelnr. | Typ     | Rördim. | Gänga  |
|------------|---------|---------|--------|
| 6013-22-13 | WE 22 L | 22 mm   | G 3/4" |
| 6013-28-17 | WE 28 L | 28 mm   | G 1"   |
| 6513-20-13 | WE 20 S | 20 mm   | G 3/4" |

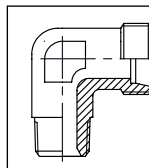

**6014/6514**

**WE-MKC**

90° vinkelkoppling – MK utv.  
Kropp  
PRODUKTGRUPP 600  
C DIN 3852

| Artikelnr. | Typ     | Rördim. | Gänga        |
|------------|---------|---------|--------------|
| 6014-06-11 | WE 6 L  | 6 mm    | M 10 x 1,0 K |
| 6014-08-13 | WE 8 L  | 8 mm    | M 12 x 1,5 K |
| 6014-10-15 | WE 10 L | 10 mm   | M 14 x 1,5 K |
| 6014-12-17 | WE 12 L | 12 mm   | M 16 x 1,5 K |
| 6014-15-19 | WE 15 L | 15 mm   | M 18 x 1,5 K |
| 6014-18-23 | WE 18 L | 18 mm   | M 22 x 1,5 K |
| 6514-06-13 | WE 6 S  | 6 mm    | M 12 x 1,5 K |
| 6514-08-15 | WE 8 S  | 8 mm    | M 14 x 1,5 K |
| 6514-10-17 | WE 10 S | 10 mm   | M 16 x 1,5 K |
| 6514-12-19 | WE 12 S | 12 mm   | M 18 x 1,5 K |
| 6514-14-21 | WE 14 S | 14 mm   | M 20 x 1,5 K |
| 6514-16-23 | WE 16 S | 16 mm   | M 22 x 1,5 K |



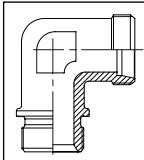

**6016/6516**

**WE – MB**

90° vinkelkoppling – M utv.  
Kropp  
B DIN 3852  
PRODUKTGRUPP 600

| Artikelnr. | Typ     | Rördim. | Gänga      |
|------------|---------|---------|------------|
| 6016-22-27 | WE 22 L | 22 mm   | M 26 x 1,5 |
| 6016-28-34 | WE 28 L | 28 mm   | M 33 x 2,0 |
| 6016-35-43 | WE 35 L | 35 mm   | M 42 x 2,0 |
| 6016-42-49 | WE 42 L | 42 mm   | M 48 x 2,0 |
| 6516-20-28 | WE 20 S | 20 mm   | M 27 x 1,5 |
| 6516-25-34 | WE 25 S | 25 mm   | M 33 x 2,0 |
| 6516-30-43 | WE 30 S | 30 mm   | M 42 x 2,0 |
| 6516-38-49 | WE 38 S | 38 mm   | M 48 x 2,0 |

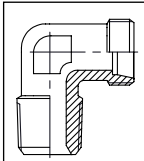

**6017/6517**

**WE – NPT**

90° Vinkelkoppling NPT utv.  
Kropp  
ANSI/ASME B1.20.1-1983  
PRODUKTGRUPP 600

| Artikelnr. | Typ     | Rördim. | Gänga             |
|------------|---------|---------|-------------------|
| 6017-06-03 | WE 6 L  | 6 mm    | 1/8"-27 NPT       |
| 6017-06-05 | WE 6 L  | 6 mm    | 1/4"-18 NPT       |
| 6017-08-05 | WE 8 L  | 8 mm    | 1/4"-18 NPT       |
| 6017-10-05 | WE 10 L | 10 mm   | 1/4"-18 NPT       |
| 6017-12-07 | WE 12 L | 12 mm   | 3/8"-18 NPT       |
| 6017-15-09 | WE 15 L | 15 mm   | 1/2"-14 NPT       |
| 6017-18-09 | WE 18 L | 18 mm   | 1/2"-14 NPT       |
| 6017-22-13 | WE 22 L | 22 mm   | 3/4"-14 NPT       |
| 6017-28-17 | WE 28 L | 28 mm   | 1"-11 1/2 NPT     |
| 6017-35-21 | WE 35 L | 35 mm   | 1 1/4"-11 1/2 NPT |
| 6017-42-25 | WE 42 L | 42 mm   | 1 1/2"-11 1/2 NPT |

|            |         |       |                   |
|------------|---------|-------|-------------------|
| 6517-06-05 | WE 6 S  | 6 mm  | 1/4"-18 NPT       |
| 6517-08-05 | WE 8 S  | 8 mm  | 1/4"-18 NPT       |
| 6517-10-07 | WE 10 S | 10 mm | 3/8"-18 NPT       |
| 6517-12-07 | WE 12 S | 12 mm | 3/8"-18 NPT       |
| 6517-14-09 | WE 14 S | 14 mm | 1/2"-14 NPT       |
| 6517-16-09 | WE 16 S | 16 mm | 1/2"-14 NPT       |
| 6517-20-13 | WE 20 S | 20 mm | 3/4"-14 NPT       |
| 6517-25-17 | WE 25 S | 25 mm | 1"-11 1/2 NPT     |
| 6517-30-21 | WE 30 S | 30 mm | 1 1/4"-11 1/2 NPT |

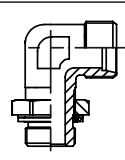

**6012/6512**

**WEE – G**

Ställbar 90° vinkelkoppling – G utv.  
Kropp  
B ISO 1179-3  
PRODUKTGRUPP 600

| Artikelnr. | Typ      | Rördim. | Gänga    |
|------------|----------|---------|----------|
| 6012-06-03 | WEE 6 L  | 6 mm    | G 1/8"   |
| 6012-08-05 | WEE 8 L  | 8 mm    | G 1/4"   |
| 6012-10-05 | WEE 10 L | 10 mm   | G 1/4"   |
| 6012-12-07 | WEE 12 L | 12 mm   | G 3/8"   |
| 6012-15-09 | WEE 15 L | 15 mm   | G 1/2"   |
| 6012-18-09 | WEE 18 L | 18 mm   | G 1/2"   |
| 6012-22-13 | WEE 22 L | 22 mm   | G 3/4"   |
| 6012-28-17 | WEE 28 L | 28 mm   | G 1"     |
| 6012-35-21 | WEE 35 L | 35 mm   | G 1 1/4" |
| 6012-42-25 | WEE 42 L | 42 mm   | G 1 1/2" |

|            |          |       |          |
|------------|----------|-------|----------|
| 6512-06-05 | WEE 6 S  | 6 mm  | G 1/4"   |
| 6512-08-05 | WEE 8 S  | 8 mm  | G 1/4"   |
| 6512-10-07 | WEE 10 S | 10 mm | G 3/8"   |
| 6512-12-07 | WEE 12 S | 12 mm | G 3/8"   |
| 6512-14-09 | WEE 14 S | 14 mm | G 1/2"   |
| 6512-16-09 | WEE 16 S | 16 mm | G 1/2"   |
| 6512-20-13 | WEE 20 S | 20 mm | G 3/4"   |
| 6512-25-17 | WEE 25 S | 25 mm | G 1"     |
| 6512-30-21 | WEE 30 S | 30 mm | G 1 1/4" |
| 6512-38-25 | WEE 38 S | 38 mm | G 1 1/2" |

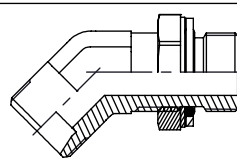

**6018/6518**

**VEE – G**

Ställbar 45° vinkelkoppling – G utv.  
O-ring med stöbricka  
ISO 1174-3  
PRODUKTGRUPP 600

| Artikelnr. | Typ      | Rördim. | Gänga    |
|------------|----------|---------|----------|
| 6018-06-03 | VEE 6 L  | 6 mm    | G 1/8"   |
| 6018-08-05 | VEE 8 L  | 8 mm    | G 1/4"   |
| 6018-10-05 | VEE 10 L | 10 mm   | G 1/4"   |
| 6018-12-07 | VEE 12 L | 12 mm   | G 3/8"   |
| 6018-15-09 | VEE 15 L | 15 mm   | G 1/2"   |
| 6018-18-09 | VEE 18 L | 18 mm   | G 1/2"   |
| 6018-22-13 | VEE 22 L | 22 mm   | G 3/4"   |
| 6018-28-17 | VEE 28 L | 28 mm   | G 1"     |
| 6018-35-21 | VEE 35 L | 35 mm   | G 1 1/4" |
| 6018-42-25 | VEE 42 L | 42 mm   | G 1 1/2" |

|            |          |       |          |
|------------|----------|-------|----------|
| 6518-06-05 | VEE 6 S  | 6 mm  | G 1/4"   |
| 6518-08-05 | VEE 8 S  | 8 mm  | G 1/4"   |
| 6518-10-07 | VEE 10 S | 10 mm | G 3/8"   |
| 6518-12-07 | VEE 12 S | 12 mm | G 3/8"   |
| 6518-14-09 | VEE 14 S | 14 mm | G 1/2"   |
| 6518-16-09 | VEE 16 S | 16 mm | G 1/2"   |
| 6518-20-13 | VEE 20 S | 20 mm | G 3/4"   |
| 6518-25-17 | VEE 25 S | 25 mm | G 1"     |
| 6518-30-21 | VEE 30 S | 30 mm | G 1 1/4" |
| 6518-38-25 | VEE 38 S | 38 mm | G 1 1/2" |

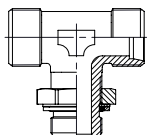

**6022/6522**

**TEE – GB**

Ställbar T-koppling – G utv.  
Kropp  
DIN 2353  
PRODUKTGRUPP 600

| Artikelnr. | Typ      | Rördim. | Gänga    |
|------------|----------|---------|----------|
| 6022-06-03 | TEE 6 L  | 6 mm    | G 1/8"   |
| 6022-08-05 | TEE 8 L  | 8 mm    | G 1/4"   |
| 6022-10-05 | TEE 10 L | 10 mm   | G 1/4"   |
| 6022-12-07 | TEE 12 L | 12 mm   | G 3/8"   |
| 6022-15-09 | TEE 15 L | 15 mm   | G 1/2"   |
| 6022-18-09 | TEE 18 L | 18 mm   | G 1/2"   |
| 6022-22-13 | TEE 22 L | 22 mm   | G 3/4"   |
| 6022-28-17 | TEE 28 L | 28 mm   | G 1"     |
| 6022-35-21 | TEE 35 L | 35 mm   | G 1 1/4" |
| 6022-42-25 | TEE 42 L | 42 mm   | G 1 1/2" |
|            |          |         |          |
| 6522-06-05 | TEE 6 S  | 6 mm    | G 1/4"   |
| 6522-08-05 | TEE 8 S  | 8 mm    | G 1/4"   |
| 6522-10-07 | TEE 10 S | 10 mm   | G 3/8"   |
| 6522-12-07 | TEE 12 S | 12 mm   | G 3/8"   |
| 6522-14-09 | TEE 14 S | 14 mm   | G 1/2"   |
| 6522-16-09 | TEE 16 S | 16 mm   | G 1/2"   |
| 6522-20-13 | TEE 20 S | 20 mm   | G 3/4"   |
| 6522-25-17 | TEE 25 S | 25 mm   | G 1"     |
| 6522-30-21 | TEE 30 S | 30 mm   | G 1 1/4" |
| 6522-38-25 | TEE 38 S | 38 mm   | G 1 1/2" |

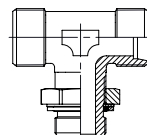

**6025/6525**

**TEE – M**

Ställbar T-koppling – M utv.  
Kropp  
PRODUKTGRUPP 600  
DIN 2353

| Artikelnr. | Typ      | Rördim. | Gänga      |
|------------|----------|---------|------------|
| 6025-06-11 | TEE 6 L  | 6 mm    | M 10 x 1,0 |
| 6025-08-13 | TEE 8 L  | 8 mm    | M 12 x 1,5 |
| 6025-10-15 | TEE 10 L | 10 mm   | M 14 x 1,5 |
| 6025-12-17 | TEE 12 L | 12 mm   | M 16 x 1,5 |
| 6025-15-19 | TEE 15 L | 15 mm   | M 18 x 1,5 |
| 6025-18-23 | TEE 18 L | 18 mm   | M 22 x 1,5 |
| 6025-22-28 | TEE 22 L | 22 mm   | M 27 x 2,0 |
| 6025-28-34 | TEE 28 L | 28 mm   | M 33 x 2,0 |
| 6025-35-43 | TEE 35 L | 35 mm   | M 42 x 2,0 |
| 6025-42-49 | TEE 42 L | 42 mm   | M 48 x 2,0 |
|            |          |         |            |
| 6525-06-13 | TEE 6 S  | 6 mm    | M 12 x 1,5 |
| 6525-08-15 | TEE 8 S  | 8 mm    | M 14 x 1,5 |
| 6525-10-17 | TEE 10 S | 10 mm   | M 16 x 1,5 |
| 6525-12-19 | TEE 12 S | 12 mm   | M 18 x 1,5 |
| 6525-14-21 | TEE 14 S | 14 mm   | M 20 x 1,5 |
| 6525-16-23 | TEE 16 S | 16 mm   | M 22 x 1,5 |
| 6525-20-28 | TEE 20 S | 20 mm   | M 27 x 2,0 |
| 6525-25-34 | TEE 25 S | 25 mm   | M 33 x 2,0 |
| 6525-30-43 | TEE 30 S | 30 mm   | M 42 x 2,0 |
| 6525-38-49 | TEE 38 S | 38 mm   | M 48 x 2,0 |

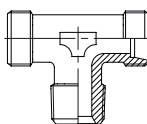

**6021/6521**

**TE-R/C**

T-koppling – R utv.  
Kropp  
C DIN 3852-2  
PRODUKTGRUPP 600

| Artikelnr. | Typ     | Rördim. | Gänga  |
|------------|---------|---------|--------|
| 6021-06-03 | TE 6 L  | 6 mm    | R 1/8" |
| 6021-08-05 | TE 8 L  | 8 mm    | R 1/4" |
| 6021-10-05 | TE 10 L | 10 mm   | R 1/4" |
| 6021-12-07 | TE 12 L | 12 mm   | R 3/8" |
| 6021-15-09 | TE 15 L | 15 mm   | R 1/2" |
| 6021-18-09 | TE 18 L | 18 mm   | R 1/2" |
|            |         |         |        |
| 6521-06-05 | TE 6 S  | 6 mm    | R 1/4" |
| 6521-08-05 | TE 8 S  | 8 mm    | R 1/4" |
| 6521-10-07 | TE 10 S | 10 mm   | R 3/8" |
| 6521-12-07 | TE 12 S | 12 mm   | R 3/8" |
| 6521-14-09 | TE 14 S | 14 mm   | R 1/2" |
| 6521-16-09 | TE 16 S | 16 mm   | R 1/2" |

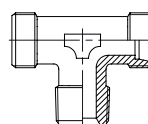

**6024**

**TE – M**

T-koppling – MK utv.  
Kropp  
PRODUKTGRUPP 600  
C DIN 3852

| Artikelnr. | Typ     | Rördim. | Gänga        |
|------------|---------|---------|--------------|
| 6024-08-13 | TE 8 L  | 8 mm    | M 12 x 1,5 K |
| 6024-10-15 | TE 10 L | 10 mm   | M 14 x 1,5 K |
| 6024-12-17 | TE 12 L | 12 mm   | M 16 x 1,5 K |
| 6024-15-19 | TE 15 L | 15 mm   | M 18 x 1,5 K |
| 6024-18-23 | TE 18 L | 18 mm   | M 22 x 1,5 K |

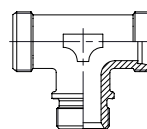

**6023/6523**

**TE-GB**

T-koppling – G utv.  
Kropp  
B DIN 3852-2  
PRODUKTGRUPP 600

| Artikelnr. | Typ     | Rördim. | Gänga    |
|------------|---------|---------|----------|
| 6023-22-13 | TE 22 L | 22 mm   | G 3/4"   |
| 6023-28-17 | TE 28 L | 28 mm   | G 1"     |
| 6023-35-21 | TE 35 L | 35 mm   | G 1 1/4" |
| 6023-42-25 | TE 42 L | 42 mm   | G 1 1/2" |
|            |         |         |          |
| 6523-20-13 | TE 20 S | 20 mm   | G 3/4"   |
| 6523-25-17 | TE 25 S | 25 mm   | G 1"     |
| 6523-30-21 | TE 30 S | 30 mm   | G 1 1/4" |
| 6523-38-25 | TE 38 S | 38 mm   | G 1 1/2" |

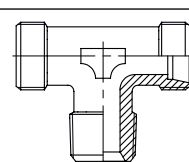

**6027**

**TE – NPT**

T-koppling – NPT utv.  
Kropp  
ANSI/ASME B1.20.1-1983  
PRODUKTGRUPP 600

| Artikelnr. | Typ     | Rördim. | Gänga    |
|------------|---------|---------|----------|
| 6027-06-03 | TE 6 L  | 6 mm    | NPT 1/8" |
| 6027-10-05 | TE 10 L | 10 mm   | NPT 1/4" |
| 6027-12-07 | TE 12 L | 12 mm   | NPT 3/8" |
| 6027-22-13 | TE 22 L | 22 mm   | NPT 3/4" |



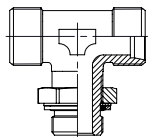

**6026/6526**

**TEE – UNF**

T-koppling – UNF utv.  
Kropp  
ISO 11926-3  
PRODUKTGRUPP 600

| Artikelnr.  | Typ      | Rördim. | Gänga        |
|-------------|----------|---------|--------------|
| 6026-06-079 | TEE 6 L  | 6 mm    | 7/16-20" UNF |
| 6026-08-079 | TEE 8 L  | 8 mm    | 7/16-20" UNF |
| 6026-10-10  | TEE 10 L | 10 mm   | 9/16-18" UNF |
| 6026-12-13  | TEE 12 L | 12 mm   | 3/4-16" UNF  |
| 6026-15-15  | TEE 15 L | 15 mm   | 7/8-14" UNF  |
| 6026-18-15  | TEE 18 L | 18 mm   | 7/8-14" UNF  |
| 6026-22-18  | TEE 22 L | 22 mm   | 11/16-12" UN |
| 6026-28-22  | TEE 28 L | 28 mm   | 15/16-12" UN |
| 6026-35-27  | TEE 35 L | 35 mm   | 15/8-12" UN  |
| 6026-42-31  | TEE 42 L | 42 mm   | 17/8-12" UN  |
| 6526-06-079 | TEE 6 S  | 6 mm    | 7/16-20" UNF |
| 6526-08-10  | TEE 8 S  | 8 mm    | 9/16-18" UNF |
| 6526-10-10  | TEE 10 S | 10 mm   | 9/16-18" UNF |
| 6526-12-13  | TEE 12 S | 12 mm   | 3/4-16" UNF  |
| 6526-14-15  | TEE 14 S | 14 mm   | 7/8-14" UNF  |
| 6526-16-15  | TEE 16 S | 16 mm   | 7/8-14" UNF  |
| 6526-20-18  | TEE 20 S | 20 mm   | 11/16-12" UN |
| 6526-25-22  | TEE 25 S | 25 mm   | 15/16-12" UN |
| 6526-30-27  | TEE 30 S | 30 mm   | 15/8-12" UN  |
| 6526-38-31  | TEE 38 S | 38 mm   | 17/8-12" UN  |

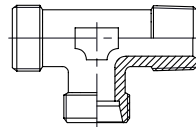

**6031/6531**

**LE – R/C**

L-koppling – R utv.  
Kropp  
C DIN 3852  
PRODUKTGRUPP 600

| Artikelnr. | Typ     | Rördim. | Gänga  |
|------------|---------|---------|--------|
| 6031-06-03 | LE 6 L  | 6 mm    | R 1/8" |
| 6031-08-05 | LE 8 L  | 8 mm    | R 1/4" |
| 6031-10-05 | LE 10 L | 10 mm   | R 1/4" |
| 6031-12-07 | LE 12 L | 12 mm   | R 3/8" |
| 6031-15-09 | LE 15 L | 15 mm   | R 1/2" |
| 6031-18-09 | LE 18 L | 18 mm   | R 1/2" |
| 6531-06-05 | LE 6 S  | 6 mm    | R 1/4" |
| 6531-08-05 | LE 8 S  | 8 mm    | R 1/4" |
| 6531-10-07 | LE 10 S | 10 mm   | R 3/8" |
| 6531-12-07 | LE 12 S | 12 mm   | R 3/8" |
| 6531-14-09 | LE 14 S | 14 mm   | R 1/2" |
| 6531-16-09 | LE 16 S | 16 mm   | R 1/2" |

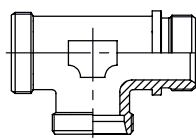

**6033/6533**

**LE – GB**

L-koppling – G utv.  
Kropp  
B DIN 3852  
PRODUKTGRUPP 600

| Artikelnr. | Typ     | Rördim. | Gänga    |
|------------|---------|---------|----------|
| 6033-22-13 | LE 22 L | 22 mm   | G 3/4"   |
| 6033-28-17 | LE 28 L | 28 mm   | G 1"     |
| 6033-35-21 | LE 35 L | 35 mm   | G 1 1/4" |
| 6033-42-25 | LE 42 L | 42 mm   | G 1 1/2" |
| 6533-20-13 | LE 20 S | 20 mm   | G 3/4"   |
| 6533-25-17 | LE 25 S | 25 mm   | G 1"     |
| 6533-30-21 | LE 30 S | 30 mm   | G 1 1/4" |
| 6533-38-25 | LE 38 S | 38 mm   | G 1 1/2" |

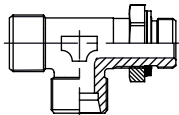

**6029/6529**

**LEE – G**

Ställbar L-koppling – G utv.  
Kropp  
ISO 1179-3  
PRODUKTGRUPP 600

| Artikelnr. | Typ      | Rördim. | Gänga    |
|------------|----------|---------|----------|
| 6029-06-03 | LEE 6 L  | 6 mm    | G 1/8"   |
| 6029-08-05 | LEE 8 L  | 8 mm    | G 1/4"   |
| 6029-10-05 | LEE 10 L | 10 mm   | G 1/4"   |
| 6029-12-07 | LEE 12 L | 12 mm   | G 3/8"   |
| 6029-15-09 | LEE 15 L | 15 mm   | G 1/2"   |
| 6029-18-09 | LEE 18 L | 18 mm   | G 1/2"   |
| 6029-22-13 | LEE 22 L | 22 mm   | G 3/4"   |
| 6029-28-17 | LEE 28 L | 28 mm   | G 1"     |
| 6029-35-21 | LEE 35 L | 35 mm   | G 1 1/4" |
| 6029-42-25 | LEE 42 L | 42 mm   | G 1 1/2" |
| 6529-06-05 | LEE 6 S  | 6 mm    | G 1/4"   |
| 6529-08-05 | LEE 8 S  | 8 mm    | G 1/4"   |
| 6529-10-07 | LEE 10 S | 10 mm   | G 3/8"   |
| 6529-12-07 | LEE 12 S | 12 mm   | G 3/8"   |
| 6529-14-09 | LEE 14 S | 14 mm   | G 1/2"   |
| 6529-16-09 | LEE 16 S | 16 mm   | G 1/2"   |
| 6529-20-13 | LEE 20 S | 20 mm   | G 3/4"   |
| 6529-25-17 | LEE 25 S | 25 mm   | G 1"     |
| 6529-30-21 | LEE 30 S | 30 mm   | G 1 1/4" |
| 6529-38-25 | LEE 38 S | 38 mm   | G 1 1/2" |

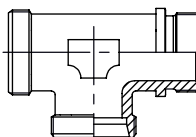

**6036**

**LE – MB**

L-koppling – M utv.  
Kropp  
BDIN 3852  
PRODUKTGRUPP 600

| Artikelnr. | Typ     | Rördim. | Gänga      |
|------------|---------|---------|------------|
| 6036-22-27 | LE 22 L | 22 mm   | M 26 x 1,5 |
| 6036-28-34 | LE 28 L | 28 mm   | M 33 x 2,0 |
| 6036-35-43 | LE 35 L | 35 mm   | M 42 x 2,0 |
| 6036-42-49 | LE 42 L | 42 mm   | M 48 x 2,0 |

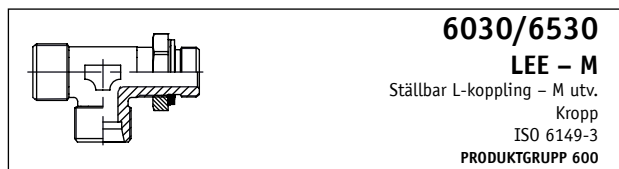

| Artikelnr. | Typ      | Rördim. | Gänga      |
|------------|----------|---------|------------|
| 6030-06-11 | LEE 6 L  | 6 mm    | M 10 x 1,0 |
| 6030-08-13 | LEE 8 L  | 8 mm    | M 12 x 1,5 |
| 6030-10-15 | LEE 10 L | 10 mm   | M 14 x 1,5 |
| 6030-12-17 | LEE 12 L | 12 mm   | M 16 x 1,5 |
| 6030-15-19 | LEE 15 L | 15 mm   | M 18 x 1,5 |
| 6030-18-23 | LEE 18 L | 18 mm   | M 22 x 1,5 |
| 6030-22-28 | LEE 22 L | 22 mm   | M 27 x 2,0 |
| 6030-28-34 | LEE 28 L | 28 mm   | M 33 x 2,0 |
| 6030-35-43 | LEE 35 L | 35 mm   | M 42 x 2,0 |
| 6030-42-49 | LEE 42 L | 42 mm   | M 48 x 2,0 |
| 6530-06-13 | LEE 6 S  | 6 mm    | M 12 x 1,5 |
| 6530-08-15 | LEE 8 S  | 8 mm    | M 14 x 1,5 |
| 6530-10-17 | LEE 10 S | 10 mm   | M 16 x 1,5 |
| 6530-12-19 | LEE 12 S | 12 mm   | M 18 x 1,5 |
| 6530-14-21 | LEE 14 S | 14 mm   | M 20 x 1,5 |
| 6530-16-23 | LEE 16 S | 16 mm   | M 22 x 1,5 |
| 6530-20-28 | LEE 20 S | 20 mm   | M 27 x 2,0 |
| 6530-25-34 | LEE 25 S | 25 mm   | M 33 x 2,0 |
| 6530-30-43 | LEE 30 S | 30 mm   | M 42 x 2,0 |
| 6530-38-49 | LEE 38 S | 38 mm   | M 48 x 2,0 |

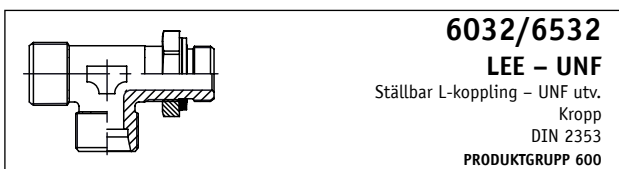

| Artikelnr.  | Typ      | Rördim. | Gänga        |
|-------------|----------|---------|--------------|
| 6032-06-079 | LEE 6 L  | 6 mm    | 7/16-20" UNF |
| 6032-08-079 | LEE 8 L  | 8 mm    | 7/16-20" UNF |
| 6032-10-10  | LEE 10 L | 10 mm   | 9/16-18" UNF |
| 6032-12-13  | LEE 12 L | 12 mm   | 3/4-16" UNF  |
| 6032-15-15  | LEE 15 L | 15 mm   | 7/8-14" UNF  |
| 6032-18-15  | LEE 18 L | 18 mm   | 7/8-14" UNF  |
| 6032-22-18  | LEE 22 L | 22 mm   | 11/16-12" UN |
| 6032-28-22  | LEE 28 L | 28 mm   | 15/16-12" UN |
| 6032-35-27  | LEE 35 L | 35 mm   | 15/8-12" UN  |
| 6032-42-31  | LEE 42 L | 42 mm   | 17/8-12" UN  |
| 6532-06-079 | LEE 6 S  | 6 mm    | 7/16-20" UNF |
| 6532-08-10  | LEE 8 S  | 8 mm    | 9/16-18" UNF |
| 6532-10-10  | LEE 10 S | 10 mm   | 9/16-18" UNF |
| 6532-12-13  | LEE 12 S | 12 mm   | 3/4-16" UNF  |
| 6532-14-15  | LEE 14 S | 14 mm   | 7/8-14" UNF  |
| 6532-16-15  | LEE 16 S | 16 mm   | 7/8-14" UNF  |
| 6532-20-18  | LEE 20 S | 20 mm   | 11/16-12" UN |
| 6532-25-22  | LEE 25 S | 25 mm   | 15/16-12" UN |
| 6532-30-27  | LEE 30 S | 30 mm   | 15/8-12" UN  |
| 6532-38-31  | LEE 38 S | 38 mm   | 17/8-12" UN  |

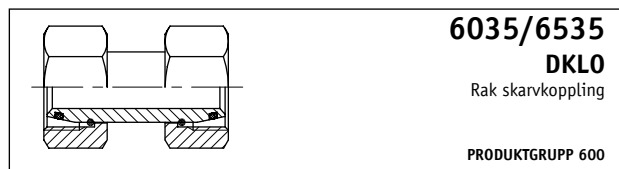

| Artikelnr. | Typ               | Rördim. |
|------------|-------------------|---------|
| 6035-06-06 | DKLO 6 x DKLO 6   | 6 mm    |
| 6035-08-08 | DKLO 8 x DKLO 8   | 8 mm    |
| 6035-10-10 | DKLO 10 x DKLO 10 | 10 mm   |
| 6035-12-12 | DKLO 12 x DKLO 12 | 12 mm   |
| 6035-15-15 | DKLO 15 x DKLO 15 | 15 mm   |
| 6035-18-18 | DKLO 18 x DKLO 18 | 18 mm   |
| 6035-22-22 | DKLO 22 x DKLO 22 | 22 mm   |
| 6035-28-28 | DKLO 28 x DKLO 28 | 28 mm   |
| 6035-35-35 | DKLO 35 x DKLO 35 | 35 mm   |
| 6035-42-42 | DKLO 42 x DKLO 42 | 42 mm   |
| 6535-06-06 | DKSO 6 x DKSO 6   | 6 mm    |
| 6535-08-08 | DKSO 8 x DKSO 8   | 8 mm    |
| 6535-10-10 | DKSO 10 x DKSO 10 | 10 mm   |
| 6535-12-12 | DKSO 12 x DKSO 12 | 12 mm   |
| 6535-14-14 | DKSO 14 x DKSO 14 | 14 mm   |
| 6535-16-16 | DKSO 16 x DKSO 16 | 16 mm   |
| 6535-20-20 | DKSO 20 x DKSO 20 | 20 mm   |
| 6535-25-25 | DKSO 25 x DKSO 25 | 25 mm   |
| 6535-30-30 | DKSO 30 x DKSO 30 | 30 mm   |
| 6535-30-38 | DKSO 30 x DKSO 38 | 30 mm   |
| 6535-38-38 | DKSO 38 x DKSO 38 | 38 mm   |

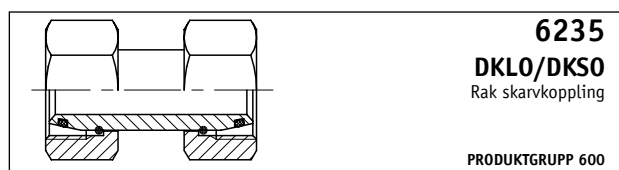

| Artikelnr. | Typ               | Rördim.     |
|------------|-------------------|-------------|
| 6235-10-12 | DKLO 10 x DKSO 12 | 10 mm-12 mm |
| 6235-10-14 | DKLO 10 x DKSO 14 | 10 mm-14 mm |
| 6235-12-14 | DKLO 12 x DKSO 14 | 12 mm-14 mm |
| 6235-12-16 | DKLO 12 x DKSO 16 | 12 mm-16 mm |
| 6235-15-16 | DKLO 15 x DKSO 16 | 15 mm-16 mm |
| 6235-15-20 | DKLO 15 x DKSO 20 | 15 mm-20 mm |
| 6235-18-20 | DKLO 18 x DKSO 20 | 18 mm-20 mm |
| 6235-18-25 | DKLO 18 x DKSO 25 | 18 mm-25 mm |
| 6235-28-25 | DKLO 28 x DKSO 25 | 28 mm-25 mm |

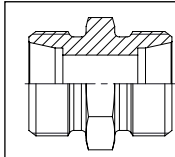

**6041/6541**

**G**  
Rak skarvkoppling  
Kropp

PRODUKTGRUPP 600

| Artikelnr. | Typ    | Rördim. |
|------------|--------|---------|
| 6041-06-07 | G 6 L  | 6 mm    |
| 6041-08-09 | G 8 L  | 8 mm    |
| 6041-10-11 | G 10 L | 10 mm   |
| 6041-12-13 | G 12 L | 12 mm   |
| 6041-15-16 | G 15 L | 15 mm   |
| 6041-18-19 | G 18 L | 18 mm   |
| 6041-22-23 | G 22 L | 22 mm   |
| 6041-28-29 | G 28 L | 28 mm   |
| 6041-35-36 | G 35 L | 35 mm   |
| 6041-42-43 | G 42 L | 42 mm   |
| 6541-06-07 | G 6 S  | 6 mm    |
| 6541-08-09 | G 8 S  | 8 mm    |
| 6541-10-11 | G 10 S | 10 mm   |
| 6541-12-13 | G 12 S | 12 mm   |
| 6541-14-15 | G 14 S | 14 mm   |
| 6541-16-17 | G 16 S | 16 mm   |
| 6541-20-21 | G 20 S | 20 mm   |
| 6541-25-26 | G 25 S | 25 mm   |
| 6541-30-31 | G 30 S | 30 mm   |
| 6541-38-39 | G 38 S | 38 mm   |

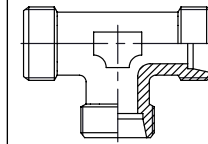

**6043/6543**

**T**  
T-skarvkoppling  
Kropp

PRODUKTGRUPP 600

| Artikelnr. | Typ    | Rördim. |
|------------|--------|---------|
| 6043-06-07 | T 6 L  | 6 mm    |
| 6043-08-09 | T 8 L  | 8 mm    |
| 6043-10-11 | T 10 L | 10 mm   |
| 6043-12-13 | T 12 L | 12 mm   |
| 6043-15-16 | T 15 L | 15 mm   |
| 6043-18-19 | T 18 L | 18 mm   |
| 6043-22-23 | T 22 L | 22 mm   |
| 6043-28-29 | T 28 L | 28 mm   |
| 6043-35-36 | T 35 L | 35 mm   |
| 6043-42-43 | T 42 L | 42 mm   |
| 6543-06-07 | T 6 S  | 6 mm    |
| 6543-08-09 | T 8 S  | 8 mm    |
| 6543-10-11 | T 10 S | 10 mm   |
| 6543-12-13 | T 12 S | 12 mm   |
| 6543-14-15 | T 14 S | 14 mm   |
| 6543-16-17 | T 16 S | 16 mm   |
| 6543-20-21 | T 20 S | 20 mm   |
| 6543-25-26 | T 25 S | 25 mm   |
| 6543-30-31 | T 30 S | 30 mm   |
| 6543-38-39 | T 38 S | 38 mm   |

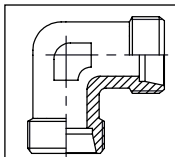

**6042/6542**

**W**  
Vinkelskarvkoppling  
Kropp

PRODUKTGRUPP 600

| Artikelnr. | Typ    | Rördim. |
|------------|--------|---------|
| 6042-06-07 | W 6 L  | 6 mm    |
| 6042-08-09 | W 8 L  | 8 mm    |
| 6042-10-11 | W 10 L | 10 mm   |
| 6042-12-13 | W 12 L | 12 mm   |
| 6042-15-16 | W 15 L | 15 mm   |
| 6042-18-19 | W 18 L | 18 mm   |
| 6042-22-23 | W 22 L | 22 mm   |
| 6042-28-29 | W 28 L | 28 mm   |
| 6042-35-36 | W 35 L | 35 mm   |
| 6042-42-43 | W 42 L | 42 mm   |
| 6542-06-07 | W 6 S  | 6 mm    |
| 6542-08-09 | W 8 S  | 8 mm    |
| 6542-10-11 | W 10 S | 10 mm   |
| 6542-12-13 | W 12 S | 12 mm   |
| 6542-14-15 | W 14 S | 14 mm   |
| 6542-16-17 | W 16 S | 16 mm   |
| 6542-20-21 | W 20 S | 20 mm   |
| 6542-25-26 | W 25 S | 25 mm   |
| 6542-30-31 | W 30 S | 30 mm   |
| 6542-38-39 | W 38 S | 38 mm   |

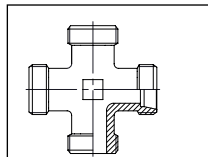

**6044/6544**

**K**  
Korsskarvkoppling  
Kropp

PRODUKTGRUPP 600

| Artikelnr. | Typ    | Rördim. |
|------------|--------|---------|
| 6044-06-07 | K 6 L  | 6 mm    |
| 6044-08-09 | K 8 L  | 8 mm    |
| 6044-10-11 | K 10 L | 10 mm   |
| 6044-12-13 | K 12 L | 12 mm   |
| 6044-15-16 | K 15 L | 15 mm   |
| 6044-18-19 | K 18 L | 18 mm   |
| 6044-22-23 | K 22 L | 22 mm   |
| 6044-28-29 | K 28 L | 28 mm   |
| 6044-35-36 | K 35 L | 35 mm   |
| 6044-42-43 | K 42 L | 42 mm   |
| 6544-06-07 | K 6 S  | 6 mm    |
| 6544-08-09 | K 8 S  | 8 mm    |
| 6544-10-11 | K 10 S | 10 mm   |
| 6544-12-13 | K 12 S | 12 mm   |
| 6544-14-15 | K 14 S | 14 mm   |
| 6544-16-17 | K 16 S | 16 mm   |
| 6544-20-21 | K 20 S | 20 mm   |
| 6544-25-26 | K 25 S | 25 mm   |
| 6544-30-31 | K 30 S | 30 mm   |
| 6544-38-39 | K 38 S | 38 mm   |

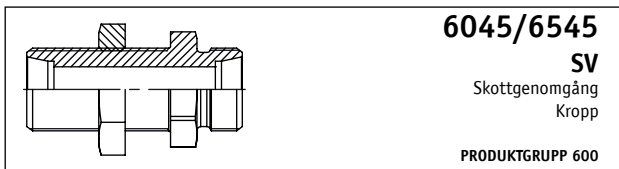

**6045/6545**

**SV**  
Skottgenomgång  
Kropp

PRODUKTGRUPP 600

| Artikelnr. | Typ     | Rördim. |
|------------|---------|---------|
| 6045-06-07 | SV 6 L  | 6 mm    |
| 6045-08-09 | SV 8 L  | 8 mm    |
| 6045-10-11 | SV 10 L | 10 mm   |
| 6045-12-13 | SV 12 L | 12 mm   |
| 6045-15-16 | SV 15 L | 15 mm   |
| 6045-18-19 | SV 18 L | 18 mm   |
| 6045-22-23 | SV 22 L | 22 mm   |
| 6045-28-29 | SV 28 L | 28 mm   |
| 6045-35-36 | SV 35 L | 35 mm   |
| 6045-42-43 | SV 42 L | 42 mm   |
| 6545-06-07 | SV 6 S  | 6 mm    |
| 6545-08-09 | SV 8 S  | 8 mm    |
| 6545-10-11 | SV 10 S | 10 mm   |
| 6545-12-13 | SV 12 S | 12 mm   |
| 6545-14-15 | SV 14 S | 14 mm   |
| 6545-16-17 | SV 16 S | 16 mm   |
| 6545-20-21 | SV 20 S | 20 mm   |
| 6545-25-26 | SV 25 S | 25 mm   |
| 6545-30-31 | SV 30 S | 30 mm   |
| 6545-38-39 | SV 38 S | 38 mm   |



**6047/6547**

**AS**  
Rak svetskoppling  
Kropp

PRODUKTGRUPP 600

| Artikelnr. | Typ     | Rördim. |
|------------|---------|---------|
| 6047-06-07 | AS 6 L  | 6 mm    |
| 6047-08-09 | AS 8 L  | 8 mm    |
| 6047-10-11 | AS 10 L | 10 mm   |
| 6047-12-13 | AS 12 L | 12 mm   |
| 6047-15-16 | AS 15 L | 15 mm   |
| 6047-18-19 | AS 18 L | 18 mm   |
| 6047-22-23 | AS 22 L | 22 mm   |
| 6047-28-29 | AS 28 L | 28 mm   |
| 6047-35-36 | AS 35 L | 35 mm   |
| 6047-42-43 | AS 42 L | 42 mm   |
| 6547-06-07 | AS 6 S  | 6 mm    |
| 6547-08-09 | AS 8 S  | 8 mm    |
| 6547-10-11 | AS 10 S | 10 mm   |
| 6547-12-13 | AS 12 S | 12 mm   |
| 6547-14-15 | AS 14 S | 14 mm   |
| 6547-16-17 | AS 16 S | 16 mm   |
| 6547-20-21 | AS 20 S | 20 mm   |
| 6547-25-26 | AS 25 S | 25 mm   |
| 6547-30-31 | AS 30 S | 30 mm   |
| 6547-38-39 | AS 38 S | 38 mm   |



**6046/6546**

**WSV**  
Vinkelskottgenomgång  
Kropp

PRODUKTGRUPP 600

| Artikelnr. | Typ      | Rördim. |
|------------|----------|---------|
| 6046-06-07 | WSV 6 L  | 6 mm    |
| 6046-08-09 | WSV 8 L  | 8 mm    |
| 6046-10-11 | WSV 10 L | 10 mm   |
| 6046-12-13 | WSV 12 L | 12 mm   |
| 6046-15-16 | WSV 15 L | 15 mm   |
| 6046-18-19 | WSV 18 L | 18 mm   |
| 6046-22-23 | WSV 22 L | 22 mm   |
| 6046-28-29 | WSV 28 L | 28 mm   |
| 6046-35-36 | WSV 35 L | 35 mm   |
| 6046-42-43 | WSV 42 L | 42 mm   |
| 6546-06-07 | WSV 6 S  | 6 mm    |
| 6546-08-09 | WSV 8 S  | 8 mm    |
| 6546-10-11 | WSV 10 S | 10 mm   |
| 6546-12-13 | WSV 12 S | 12 mm   |
| 6546-14-15 | WSV 14 S | 14 mm   |
| 6546-16-17 | WSV 16 S | 16 mm   |
| 6546-20-21 | WSV 20 S | 20 mm   |
| 6546-25-26 | WSV 25 S | 25 mm   |
| 6546-30-31 | WSV 30 S | 30 mm   |
| 6546-38-39 | WSV 38 S | 38 mm   |

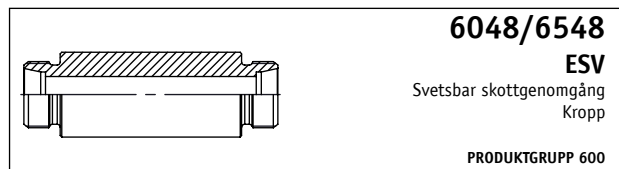

**6048/6548**

**ESV**  
Svetsbar skottgenomgång  
Kropp

PRODUKTGRUPP 600

| Artikelnr. | Typ      | Rördim. |
|------------|----------|---------|
| 6048-06-07 | ESV 6 L  | 6 mm    |
| 6048-08-09 | ESV 8 L  | 8 mm    |
| 6048-10-11 | ESV 10 L | 10 mm   |
| 6048-12-13 | ESV 12 L | 12 mm   |
| 6048-15-16 | ESV 15 L | 15 mm   |
| 6048-18-19 | ESV 18 L | 18 mm   |
| 6048-22-23 | ESV 22 L | 22 mm   |
| 6048-28-29 | ESV 28 L | 28 mm   |
| 6048-35-36 | ESV 35 L | 35 mm   |
| 6048-42-43 | ESV 42 L | 42 mm   |
| 6548-06-07 | ESV 6 S  | 6 mm    |
| 6548-08-09 | ESV 8 S  | 8 mm    |
| 6548-10-11 | ESV 10 S | 10 mm   |
| 6548-12-13 | ESV 12 S | 12 mm   |
| 6548-14-15 | ESV 14 S | 14 mm   |
| 6548-16-17 | ESV 16 S | 16 mm   |
| 6548-20-21 | ESV 20 S | 20 mm   |
| 6548-25-26 | ESV 25 S | 25 mm   |
| 6548-30-31 | ESV 30 S | 30 mm   |
| 6548-38-39 | ESV 38 S | 38 mm   |





**6049/6549**  
**WAS**  
 Vinkelsvetskoppling  
 Kropp  
 PRODUKTGRUPP 600

| Artikelnr. | Typ      | Rördim. |
|------------|----------|---------|
| 6049-06-07 | WAS 6 L  | 6 mm    |
| 6049-08-09 | WAS 8 L  | 8 mm    |
| 6049-10-11 | WAS 10 L | 10 mm   |
| 6049-12-13 | WAS 12 L | 12 mm   |
| 6049-15-16 | WAS 15 L | 15 mm   |
| 6049-18-19 | WAS 18 L | 18 mm   |
| 6049-22-23 | WAS 22 L | 22 mm   |
| 6049-28-29 | WAS 28 L | 28 mm   |
| 6049-35-36 | WAS 35 L | 35 mm   |
| 6049-42-43 | WAS 42 L | 42 mm   |
|            |          |         |
| 6549-06-07 | WAS 6 S  | 6 mm    |
| 6549-08-09 | WAS 8 S  | 8 mm    |
| 6549-10-11 | WAS 10 S | 10 mm   |
| 6549-12-13 | WAS 12 S | 12 mm   |
| 6549-14-15 | WAS 14 S | 14 mm   |
| 6549-16-17 | WAS 16 S | 16 mm   |
| 6549-20-21 | WAS 20 S | 20 mm   |
| 6549-25-26 | WAS 25 S | 25 mm   |
| 6549-30-31 | WAS 30 S | 30 mm   |
| 6549-38-39 | WAS 38 S | 38 mm   |

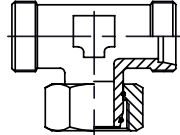

**6061/6561**  
**EVT-0**  
 Ställbar T-koppling med O-ring  
 Kropp  
 PRODUKTGRUPP 600

| Artikelnr. | Typ       | Rördim. |
|------------|-----------|---------|
| 6061-06-07 | EVTO 6 L  | 6 mm    |
| 6061-08-09 | EVTO 8 L  | 8 mm    |
| 6061-10-11 | EVTO 10 L | 10 mm   |
| 6061-12-13 | EVTO 12 L | 12 mm   |
| 6061-15-16 | EVTO 15 L | 15 mm   |
| 6061-18-19 | EVTO 18 L | 18 mm   |
| 6061-22-23 | EVTO 22 L | 22 mm   |
| 6061-28-29 | EVTO 28 L | 28 mm   |
| 6061-35-36 | EVTO 35 L | 35 mm   |
| 6061-42-43 | EVTO 42 L | 42 mm   |
|            |           |         |
| 6561-06-07 | EVTO 6 S  | 6 mm    |
| 6561-08-09 | EVTO 8 S  | 8 mm    |
| 6561-10-11 | EVTO 10 S | 10 mm   |
| 6561-12-13 | EVTO 12 S | 12 mm   |
| 6561-14-15 | EVTO 14 S | 14 mm   |
| 6561-16-17 | EVTO 16 S | 16 mm   |
| 6561-20-21 | EVTO 20 S | 20 mm   |
| 6561-25-26 | EVTO 25 S | 25 mm   |
| 6561-30-31 | EVTO 30 S | 30 mm   |
| 6561-38-39 | EVTO 38 S | 38 mm   |



**6051/6551**  
**EVW-0**  
 Ställbar vinkelkoppling med O-ring  
 Kropp  
 PRODUKTGRUPP 600

| Artikelnr. | Typ       | Rördim. |
|------------|-----------|---------|
| 6051-06-07 | EVWO 6 L  | 6 mm    |
| 6051-08-09 | EVWO 8 L  | 8 mm    |
| 6051-10-11 | EVWO 10 L | 10 mm   |
| 6051-12-13 | EVWO 12 L | 12 mm   |
| 6051-15-16 | EVWO 15 L | 15 mm   |
| 6051-18-19 | EVWO 18 L | 18 mm   |
| 6051-22-23 | EVWO 22 L | 22 mm   |
| 6051-28-29 | EVWO 28 L | 28 mm   |
| 6051-35-36 | EVWO 35 L | 35 mm   |
| 6051-42-43 | EVWO 42 L | 42 mm   |
|            |           |         |
| 6551-06-07 | EVWO 6 S  | 6 mm    |
| 6551-08-09 | EVWO 8 S  | 8 mm    |
| 6551-10-11 | EVWO 10 S | 10 mm   |
| 6551-12-13 | EVWO 12 S | 12 mm   |
| 6551-14-15 | EVWO 14 S | 14 mm   |
| 6551-16-17 | EVWO 16 S | 16 mm   |
| 6551-20-21 | EVWO 20 S | 20 mm   |
| 6551-25-26 | EVWO 25 S | 25 mm   |
| 6551-30-31 | EVWO 30 S | 30 mm   |
| 6551-38-39 | EVWO 38 S | 38 mm   |

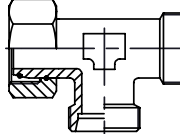

**6071/6571**  
**EVL-0**  
 Ställbar L-koppling med O-ring  
 Kropp  
 PRODUKTGRUPP 600

| Artikelnr. | Typ      | Rördim. |
|------------|----------|---------|
| 6071-06-07 | EVL 6 L  | 6 mm    |
| 6071-08-09 | EVL 8 L  | 8 mm    |
| 6071-10-11 | EVL 10 L | 10 mm   |
| 6071-12-13 | EVL 12 L | 12 mm   |
| 6071-15-16 | EVL 15 L | 15 mm   |
| 6071-18-19 | EVL 18 L | 18 mm   |
| 6071-22-23 | EVL 22 L | 22 mm   |
| 6071-28-29 | EVL 28 L | 28 mm   |
| 6071-35-36 | EVL 35 L | 35 mm   |
| 6071-42-43 | EVL 42 L | 42 mm   |
|            |          |         |
| 6571-06-07 | EVL 6 S  | 6 mm    |
| 6571-08-09 | EVL 8 S  | 8 mm    |
| 6571-10-11 | EVL 10 S | 10 mm   |
| 6571-12-13 | EVL 12 S | 12 mm   |
| 6571-14-15 | EVL 14 S | 14 mm   |
| 6571-16-17 | EVL 16 S | 16 mm   |
| 6571-20-21 | EVL 20 S | 20 mm   |
| 6571-25-26 | EVL 25 S | 25 mm   |
| 6571-30-31 | EVL 30 S | 30 mm   |
| 6571-38-39 | EVL 38 S | 38 mm   |

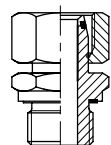

**6090/6590**  
**EVGEO – G/ED**  
Rak inskravningsstuds  
med förmonterad mutter och O-ring  
ISO 1179-2  
PRODUKTGRUPP 600

| Artikelnr. | Typ        | Rördim. | Gänga    |
|------------|------------|---------|----------|
| 6090-06-02 | EVGEO 6 L  | 6 mm    | G 1/8"   |
| 6090-06-04 | EVGEO 6 L  | 6 mm    | G 1/4"   |
| 6090-08-04 | EVGEO 8 L  | 8 mm    | G 1/4"   |
| 6090-10-04 | EVGEO 10 L | 10 mm   | G 1/4"   |
| 6090-10-06 | EVGEO 10 L | 10 mm   | G 3/8"   |
| 6090-12-04 | EVGEO 12 L | 12 mm   | G 1/4"   |
| 6090-12-06 | EVGEO 12 L | 12 mm   | G 3/8"   |
| 6090-12-08 | EVGEO 12 L | 12 mm   | G 1/2"   |
| 6090-15-08 | EVGEO 15 L | 15 mm   | G 1/2"   |
| 6090-18-08 | EVGEO 18 L | 18 mm   | G 1/2"   |
| 6096-18-12 | EVGEO 18 L | 18 mm   | G 3/4"   |
| 6090-22-12 | EVGEO 22 L | 22 mm   | G 3/4"   |
| 6090-28-16 | EVGEO 28 L | 28 mm   | G 1"     |
| 6090-35-20 | EVGEO 35 L | 35 mm   | G 1 1/4" |
| 6090-42-24 | EVGEO 42 L | 42 mm   | G 1 1/2" |
| 6590-06-04 | EVGEO 6 S  | 6 mm    | G 1/4"   |
| 6590-08-04 | EVGEO 8 S  | 8 mm    | G 1/4"   |
| 6590-10-04 | EVGEO 10 S | 10 mm   | G 1/4"   |
| 6590-10-06 | EVGEO 10 S | 10 mm   | G 3/8"   |
| 6590-12-06 | EVGEO 12 S | 12 mm   | G 3/8"   |
| 6590-12-08 | EVGEO 12 S | 12 mm   | G 1/2"   |
| 6590-14-08 | EVGEO 14 S | 14 mm   | G 1/2"   |
| 6590-16-06 | EVGEO 16 S | 16 mm   | G 3/8"   |
| 6590-16-08 | EVGEO 16 S | 16 mm   | G 1/2"   |
| 6590-16-12 | EVGEO 16 S | 16 mm   | G 3/4"   |
| 6590-20-12 | EVGEO 20 S | 20 mm   | G 3/4"   |
| 6590-25-12 | EVGEO 25 S | 25 mm   | G 3/4"   |
| 6590-25-16 | EVGEO 25 S | 25 mm   | G 1"     |
| 6590-30-20 | EVGEO 30 S | 30 mm   | G 1 1/4" |
| 6590-38-24 | EVGEO 38 S | 38 mm   | G 1 1/2" |

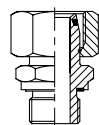

**6092/6592**  
**EVGEO – M/ED**  
Rak inskravningsstuds  
med förmonterad mutter och O-ring  
ISO 9974-2  
PRODUKTGRUPP 600

| Artikelnr. | Typ        | Rördim. | Gänga      |
|------------|------------|---------|------------|
| 6092-06-10 | EVGEO 6 L  | 6 mm    | M 10 x 1.0 |
| 6092-08-12 | EVGEO 8 L  | 8 mm    | M 12 x 1.5 |
| 6092-10-14 | EVGEO 10 L | 10 mm   | M 14 x 1.5 |
| 6092-12-16 | EVGEO 12 L | 12 mm   | M 16 x 1.5 |
| 6092-15-18 | EVGEO 15 L | 15 mm   | M 18 x 1.5 |
| 6092-18-22 | EVGEO 18 L | 18 mm   | M 22 x 1.5 |
| 6092-22-26 | EVGEO 22 L | 22 mm   | M 26 x 1.5 |
| 6092-28-33 | EVGEO 28 L | 28 mm   | M 33 x 2.0 |
| 6092-35-42 | EVGEO 35 L | 35 mm   | M 42 x 2.0 |
| 6092-42-48 | EVGEO 42 L | 42 mm   | M 48 x 2.0 |
| 6592-06-12 | EVGEO 6 S  | 6 mm    | M 12 x 1.5 |
| 6592-08-14 | EVGEO 8 S  | 8 mm    | M 14 x 1.5 |
| 6592-10-16 | EVGEO 10 S | 10 mm   | M 16 x 1.5 |
| 6592-12-18 | EVGEO 12 S | 12 mm   | M 18 x 1.5 |
| 6592-14-20 | EVGEO 14 S | 14 mm   | M 20 x 1.5 |
| 6592-16-22 | EVGEO 16 S | 16 mm   | M 22 x 1.5 |
| 6592-20-27 | EVGEO 20 S | 20 mm   | M 27 x 2.0 |
| 6592-25-33 | EVGEO 25 S | 25 mm   | M 33 x 2.0 |
| 6592-30-42 | EVGEO 30 S | 30 mm   | M 42 x 2.0 |
| 6592-38-48 | EVGEO 38 S | 38 mm   | M 48 x 2.0 |

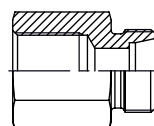

**6101/6601**  
**GAI – G**  
Rak koppling – G inv.  
Kropp  
PRODUKTGRUPP 600

| Artikelnr. | Typ      | Rördim. | Gänga    |
|------------|----------|---------|----------|
| 6101-06-03 | GAI 6 L  | 6 mm    | G 1/8"   |
| 6101-08-05 | GAI 8 L  | 8 mm    | G 1/4"   |
| 6101-08-07 | GAI 8 L  | 8 mm    | G 3/8"   |
| 6101-10-05 | GAI 10 L | 10 mm   | G 1/4"   |
| 6101-12-05 | GAI 12 L | 12 mm   | G 1/4"   |
| 6101-12-07 | GAI 12 L | 12 mm   | G 3/8"   |
| 6101-12-09 | GAI 12 L | 12 mm   | G 1/2"   |
| 6101-15-09 | GAI 15 L | 15 mm   | G 1/2"   |
| 6101-18-09 | GAI 18 L | 18 mm   | G 1/2"   |
| 6101-22-13 | GAI 22 L | 22 mm   | G 3/4"   |
| 6101-28-17 | GAI 28 L | 28 mm   | G 1"     |
| 6101-35-21 | GAI 35 L | 35 mm   | G 1 1/4" |
| 6101-42-25 | GAI 42 L | 42 mm   | G 1 1/2" |
| 6601-06-05 | GAI 6 S  | 6 mm    | G 1/4"   |
| 6601-08-05 | GAI 8 S  | 8 mm    | G 1/4"   |
| 6601-10-07 | GAI 10 S | 10 mm   | G 3/8"   |
| 6601-12-07 | GAI 12 S | 12 mm   | G 3/8"   |
| 6601-14-09 | GAI 14 S | 14 mm   | G 1/2"   |
| 6601-16-09 | GAI 16 S | 16 mm   | G 1/2"   |
| 6601-20-13 | GAI 20 S | 20 mm   | G 3/4"   |
| 6601-25-17 | GAI 25 S | 25 mm   | G 1"     |
| 6601-30-21 | GAI 30 S | 30 mm   | G 1 1/4" |
| 6601-38-25 | GAI 38 S | 38 mm   | G 1 1/2" |

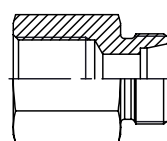

**6102/6602**  
**GAI – M**  
Rak koppling – M inv.  
Kropp  
PRODUKTGRUPP 600

| Artikelnr. | Typ      | Rördim. | Gänga      |
|------------|----------|---------|------------|
| 6102-06-11 | GAI 6 L  | 6 mm    | M 10 x 1.0 |
| 6102-08-13 | GAI 8 L  | 8 mm    | M 12 x 1.5 |
| 6102-10-15 | GAI 10 L | 10 mm   | M 14 x 1.5 |
| 6102-12-17 | GAI 12 L | 12 mm   | M 16 x 1.5 |
| 6102-15-19 | GAI 15 L | 15 mm   | M 18 x 1.5 |
| 6102-18-23 | GAI 18 L | 18 mm   | M 22 x 1.5 |
| 6102-22-27 | GAI 22 L | 22 mm   | M 26 x 1.5 |
| 6602-06-13 | GAI 6 S  | 6 mm    | M 12 x 1.5 |
| 6602-08-15 | GAI 8 S  | 8 mm    | M 14 x 1.5 |
| 6602-10-17 | GAI 10 S | 10 mm   | M 16 x 1.5 |
| 6602-12-19 | GAI 12 S | 12 mm   | M 18 x 1.5 |
| 6602-14-21 | GAI 14 S | 14 mm   | M 20 x 1.5 |
| 6602-16-23 | GAI 16 S | 16 mm   | M 22 x 1.5 |
| 6602-20-28 | GAI 20 S | 20 mm   | M 27 x 2.0 |

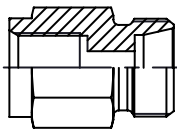
**6103/6603**

**MAV - G**  
Manometerkoppling  
Kropp

PRODUKTGRUPP 600

| Artikelnr. | Typ            | Rördim. | Gänga  |
|------------|----------------|---------|--------|
| 6103-06-05 | MAV 6 L        | 6 mm    | G 1/4" |
| 6103-08-05 | MAV 8 L        | 8 mm    | G 1/4" |
| 6103-10-05 | MAV 10 L       | 10 mm   | G 1/4" |
| 6103-12-05 | MAV 12 L       | 12 mm   | G 1/4" |
| 6603-06-09 | MAV 6 S        | 6 mm    | G 1/2" |
| 6603-08-05 | MAV 8 S        | 8 mm    | G 1/4" |
| 6603-08-09 | MAV 8 S        | 8 mm    | G 1/2" |
| 6603-10-09 | MAV 10 S       | 10 mm   | G 1/2" |
| 6603-12-09 | MAV 12 S       | 12 mm   | G 1/2" |
| 6103-13-04 | Skärkantring   |         | G 1/4" |
| 6603-13-06 | Kopparpackning |         | G 3/8" |
| 6603-13-08 | Skärkantring   |         | G 1/2" |

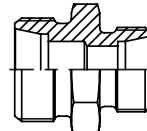
**6105/6605**

**RED**  
Reducering  
Kropp

PRODUKTGRUPP 600

| Artikelnr. | Typ         | Rördim.     |
|------------|-------------|-------------|
| 6105-08-07 | RED 8/6 L   | 8 mm-6 mm   |
| 6105-10-07 | RED 10/6 L  | 10 mm-6 mm  |
| 6105-10-09 | RED 10/8 L  | 10 mm-8 mm  |
| 6105-12-07 | RED 12/6 L  | 12 mm-6 mm  |
| 6105-12-09 | RED 12/8 L  | 12 mm-8 mm  |
| 6105-12-11 | RED 12/10 L | 12 mm-10 mm |
| 6105-15-07 | RED 15/6 L  | 15 mm-6 mm  |
| 6105-15-09 | RED 15/8 L  | 15 mm-8 mm  |
| 6105-15-11 | RED 15/10 L | 15 mm-10 mm |
| 6105-15-13 | RED 15/12 L | 15 mm-12 mm |
| 6105-18-09 | RED 18/8 L  | 18 mm-8 mm  |
| 6105-18-11 | RED 18/10 L | 18 mm-10 mm |
| 6105-18-13 | RED 18/12 L | 18 mm-12 mm |
| 6105-18-16 | RED 18/15 L | 18 mm-15 mm |
| 6105-22-13 | RED 22/12 L | 22 mm-12 mm |
| 6105-22-16 | RED 22/15 L | 22 mm-15 mm |
| 6105-22-19 | RED 22/18 L | 22 mm-18 mm |
| 6105-28-11 | RED 28/10 L | 28 mm-10 mm |
| 6105-28-16 | RED 28/15 L | 28 mm-15 mm |
| 6105-28-19 | RED 28/18 L | 28 mm-18 mm |
| 6105-28-23 | RED 28/22 L | 28 mm-22 mm |
| 6105-35-23 | RED 35/22 L | 35 mm-22 mm |
| 6105-35-29 | RED 35/28 L | 35 mm-28 mm |

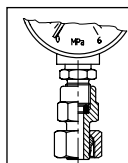
**6204/6704**

**MAV0-EV G**  
Manometerkoppling för monterad  
med O-ring  
Komplet

PRODUKTGRUPP 600

| Artikelnr. | Typ         | Rördim. | Gänga  |
|------------|-------------|---------|--------|
| 6204-06-04 | MAV-EV 6 L  | 6 mm    | G 1/4" |
| 6204-08-04 | MAV-EV 8 L  | 8 mm    | G 1/4" |
| 6204-10-04 | MAV-EV 10 L | 10 mm   | G 1/4" |
| 6204-12-04 | MAV-EV 12 L | 12 mm   | G 1/4" |
| 6704-06-08 | MAV-EV 6 S  | 6 mm    | G 1/2" |
| 6704-08-08 | MAV-EV 8 S  | 8 mm    | G 1/2" |
| 6704-10-08 | MAV-EV 10 S | 10 mm   | G 1/2" |
| 6704-12-08 | MAV-EV 12 S | 12 mm   | G 1/2" |

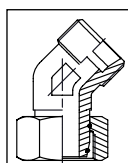
**6055/6555**

**EV-0**  
Ställbar 45° vinkelkoppling med O-ring  
Kropp

PRODUKTGRUPP 600

| Artikelnr. | Typ     | Rördim. |
|------------|---------|---------|
| 6055-06-07 | EV 6 L  | 6 mm    |
| 6055-08-09 | EV 8 L  | 8 mm    |
| 6055-10-11 | EV 10 L | 10 mm   |
| 6055-12-13 | EV 12 L | 12 mm   |
| 6055-15-16 | EV 15 L | 15 mm   |
| 6055-18-19 | EV 18 L | 18 mm   |
| 6055-22-23 | EV 22 L | 22 mm   |
| 6055-28-29 | EV 28 L | 28 mm   |
| 6055-35-36 | EV 35 L | 35 mm   |
| 6055-42-43 | EV 42 L | 42 mm   |
| 6555-06-07 | EV 6 S  | 6 mm    |
| 6555-08-09 | EV 8 S  | 8 mm    |
| 6555-10-11 | EV 10 S | 10 mm   |
| 6555-12-13 | EV 12 S | 12 mm   |
| 6555-14-15 | EV 14 S | 14 mm   |
| 6555-16-17 | EV 16 S | 16 mm   |
| 6555-20-21 | EV 20 S | 20 mm   |
| 6555-25-26 | EV 25 S | 25 mm   |
| 6555-30-31 | EV 30 S | 30 mm   |
| 6555-38-39 | EV 38 S | 38 mm   |

|            |             |             |
|------------|-------------|-------------|
| 6605-08-07 | RED 8/6 S   | 8 mm-6 mm   |
| 6605-10-07 | RED 10/6 S  | 10 mm-6 mm  |
| 6605-10-09 | RED 10/8 S  | 10 mm-8 mm  |
| 6605-12-07 | RED 12/6 S  | 12 mm-6 mm  |
| 6605-12-09 | RED 12/8 S  | 12 mm-8 mm  |
| 6605-12-11 | RED 12/10 S | 12 mm-10 mm |
| 6605-14-11 | RED 14/10 S | 14 mm-10 mm |
| 6605-14-13 | RED 14/12 S | 14 mm-12 mm |
| 6605-16-11 | RED 16/10 S | 16 mm-10 mm |
| 6605-16-13 | RED 16/12 S | 16 mm-12 mm |
| 6605-16-15 | RED 16/14 S | 16 mm-14 mm |
| 6605-20-11 | RED 20/10 S | 20 mm-10 mm |
| 6605-20-13 | RED 20/12 S | 20 mm-12 mm |
| 6605-20-15 | RED 20/14 S | 20 mm-14 mm |
| 6605-20-17 | RED 20/16 S | 20 mm-16 mm |
| 6605-25-17 | RED 25/16 S | 25 mm-16 mm |
| 6605-25-21 | RED 25/20 S | 25 mm-20 mm |
| 6605-30-21 | RED 30/20 S | 30 mm-20 mm |
| 6605-30-26 | RED 30/25 S | 30 mm-25 mm |
| 6605-38-26 | RED 38/25 S | 38 mm-25 mm |
| 6605-38-31 | RED 38/30 S | 38 mm-30 mm |



**6109/6609**

**KOR-O**  
Rak reducering med O-ring  
Kropp

PRODUKTGRUPP 600

| Artikelnr. | Typ | Rördim. |
|------------|-----|---------|
|------------|-----|---------|

|            |               |             |
|------------|---------------|-------------|
| 6109-08-07 | KOR O 8/6 L   | 8 mm-6 mm   |
| 6109-10-07 | KOR O 10/6 L  | 10 mm-6 mm  |
| 6109-10-09 | KOR O 10/8 L  | 10 mm-8 mm  |
| 6109-12-07 | KOR O 12/6 L  | 12 mm-6 mm  |
| 6109-12-09 | KOR O 12/8 L  | 12 mm-8 mm  |
| 6109-12-11 | KOR O 12/10 L | 12 mm-10 mm |
| 6109-15-07 | KOR O 15/6 L  | 15 mm-6 mm  |
| 6109-15-09 | KOR O 15/8 L  | 15 mm-8 mm  |
| 6109-15-11 | KOR O 15/10 L | 15 mm-10 mm |
| 6109-15-13 | KOR O 15/12 L | 15 mm-12 mm |
| 6109-18-07 | KOR O 18/6 L  | 18 mm-6 mm  |
| 6109-18-09 | KOR O 18/8 L  | 18 mm-8 mm  |
| 6109-18-11 | KOR O 18/10 L | 18 mm-10 mm |
| 6109-18-13 | KOR O 18/12 L | 18 mm-12 mm |
| 6109-18-16 | KOR O 18/15 L | 18 mm-15 mm |
| 6109-22-07 | KOR O 22/6 L  | 22 mm-6 mm  |
| 6109-22-09 | KOR O 22/8 L  | 22 mm-8 mm  |
| 6109-22-11 | KOR O 22/10 L | 22 mm-10 mm |
| 6109-22-13 | KOR O 22/12 L | 22 mm-12 mm |
| 6109-22-16 | KOR O 22/15 L | 22 mm-15 mm |
| 6109-22-19 | KOR O 22/18 L | 22 mm-18 mm |
| 6109-28-07 | KOR O 28/6 L  | 28 mm-6 mm  |
| 6109-28-09 | KOR O 28/8 L  | 28 mm-8 mm  |
| 6109-28-11 | KOR O 28/10 L | 28 mm-10 mm |
| 6109-28-13 | KOR O 28/12 L | 28 mm-12 mm |
| 6109-28-16 | KOR O 28/15 L | 28 mm-15 mm |
| 6109-28-19 | KOR O 28/18 L | 28 mm-18 mm |
| 6109-28-23 | KOR O 28/22 L | 28 mm-22 mm |
| 6109-35-07 | KOR O 35/6 L  | 35 mm-6 mm  |
| 6109-35-09 | KOR O 35/8 L  | 35 mm-8 mm  |
| 6109-35-11 | KOR O 35/10 L | 35 mm-10 mm |
| 6109-35-13 | KOR O 35/12 L | 35 mm-12 mm |
| 6109-35-16 | KOR O 35/15 L | 35 mm-15 mm |
| 6109-35-19 | KOR O 35/18 L | 35 mm-18 mm |
| 6109-35-23 | KOR O 35/22 L | 35 mm-22 mm |
| 6109-35-29 | KOR O 35/28 L | 35 mm-28 mm |
| 6109-42-07 | KOR O 42/6 L  | 42 mm-6 mm  |
| 6109-42-09 | KOR O 42/8 L  | 42 mm-8 mm  |
| 6109-42-11 | KOR O 42/10 L | 42 mm-10 mm |
| 6109-42-13 | KOR O 42/12 L | 42 mm-12 mm |
| 6109-42-16 | KOR O 42/15 L | 42 mm-15 mm |
| 6109-42-19 | KOR O 42/18 L | 42 mm-18 mm |
| 6109-42-23 | KOR O 42/22 L | 42 mm-22 mm |
| 6109-42-29 | KOR O 42/28 L | 42 mm-28 mm |
| 6109-42-36 | KOR O 42/35 L | 42 mm-35 mm |
| 6609-08-07 | KOR O 8/6 S   | 8 mm-6 mm   |
| 6609-10-07 | KOR O 10/6 S  | 10 mm-6 mm  |
| 6609-10-09 | KOR O 10/8 S  | 10 mm-8 mm  |
| 6609-12-07 | KOR O 12/6 S  | 12 mm-6 mm  |
| 6609-12-09 | KOR O 12/8 S  | 12 mm-8 mm  |
| 6609-12-11 | KOR O 12/10 S | 12 mm-10 mm |
| 6609-14-07 | KOR O 14/6 S  | 14 mm-6 mm  |
| 6609-14-09 | KOR O 14/8 S  | 14 mm-8 mm  |
| 6609-14-11 | KOR O 14/10 S | 14 mm-10 mm |
| 6609-14-13 | KOR O 14/12 S | 14 mm-12 mm |
| 6609-16-07 | KOR O 16/6 S  | 16 mm-6 mm  |
| 6609-16-09 | KOR O 16/8 S  | 16 mm-8 mm  |
| 6609-16-11 | KOR O 16/10 S | 16 mm-10 mm |
| 6609-16-13 | KOR O 16/12 S | 16 mm-12 mm |
| 6609-16-15 | KOR O 16/14 S | 16 mm-14 mm |
| 6609-20-07 | KOR O 20/6 S  | 20 mm-6 mm  |

| Artikelnr. | Typ | Rördim. |
|------------|-----|---------|
|------------|-----|---------|

|            |               |             |
|------------|---------------|-------------|
| 6609-20-09 | KOR O 20/8 S  | 20 mm-8 mm  |
| 6609-20-11 | KOR O 20/10 S | 20 mm-10 mm |
| 6609-20-13 | KOR O 20/12 S | 20 mm-12 mm |
| 6609-20-15 | KOR O 20/14 S | 20 mm-14 mm |
| 6609-20-17 | KOR O 20/16 S | 20 mm-16 mm |
| 6609-25-07 | KOR O 25/6 S  | 25 mm-6 mm  |
| 6609-25-09 | KOR O 25/8 S  | 25 mm-8 mm  |
| 6609-25-11 | KOR O 25/10 S | 25 mm-10 mm |
| 6609-25-13 | KOR O 25/12 S | 25 mm-12 mm |
| 6609-25-15 | KOR O 25/14 S | 25 mm-14 mm |
| 6609-25-17 | KOR O 25/16 S | 25 mm-16 mm |
| 6609-25-21 | KOR O 25/20 S | 25 mm-20 mm |
| 6609-30-09 | KOR O 30/8 S  | 30 mm-8 mm  |
| 6609-30-11 | KOR O 30/10 S | 30 mm-10 mm |
| 6609-30-13 | KOR O 30/12 S | 30 mm-12 mm |
| 6609-30-17 | KOR O 30/16 S | 30 mm-16 mm |
| 6609-30-21 | KOR O 30/20 S | 30 mm-20 mm |
| 6609-30-26 | KOR O 30/25 S | 30 mm-25 mm |
| 6609-38-09 | KOR O 38/8 S  | 38 mm-8 mm  |
| 6609-38-13 | KOR O 38/12 S | 38 mm-12 mm |
| 6609-38-17 | KOR O 38/16 S | 38 mm-16 mm |
| 6609-38-21 | KOR O 38/20 S | 38 mm-20 mm |
| 6609-38-26 | KOR O 38/25 S | 38 mm-25 mm |
| 6609-38-31 | KOR O 38/30 S | 38 mm-30 mm |

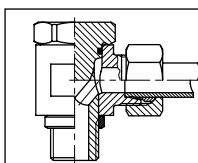

**6110/6610**

**WHB - G**  
Banjo - G utv. genomgående bult  
Komplett  
Skärkantring, stryppfri  
PRODUKTGRUPP 600

| Artikelnr. | Typ | Rördim. | Gänga |
|------------|-----|---------|-------|
|------------|-----|---------|-------|

|            |          |       |          |
|------------|----------|-------|----------|
| 6110-06-02 | WHB 6 L  | 6 mm  | G 1/8"   |
| 6110-08-04 | WHB 8 L  | 8 mm  | G 1/4"   |
| 6110-10-04 | WHB 10 L | 10 mm | G 1/4"   |
| 6110-12-04 | WHB 12 L | 12 mm | G 1/4"   |
| 6110-12-06 | WHB 12 L | 12 mm | G 3/8"   |
| 6110-15-08 | WHB 15 L | 15 mm | G 1/2"   |
| 6110-18-08 | WHB 18 L | 18 mm | G 1/2"   |
| 6110-22-12 | WHB 22 L | 22 mm | G 3/4"   |
| 6110-28-16 | WHB 28 L | 28 mm | G 1"     |
| 6110-35-20 | WHB 35 L | 35 mm | G 1 1/4" |
| 6110-42-24 | WHB 42 L | 42 mm | G 1 1/2" |
| 6610-06-04 | WHB 6 S  | 6 mm  | G 1/4"   |
| 6610-08-04 | WHB 8 S  | 8 mm  | G 1/4"   |
| 6610-10-06 | WHB 10 S | 10 mm | G 3/8"   |
| 6610-12-06 | WHB 12 S | 12 mm | G 3/8"   |
| 6610-14-08 | WHB 14 S | 14 mm | G 1/2"   |
| 6610-16-08 | WHB 16 S | 16 mm | G 1/2"   |
| 6610-20-12 | WHB 20 S | 20 mm | G 3/4"   |
| 6610-25-16 | WHB 25 S | 25 mm | G 1"     |
| 6610-30-20 | WHB 30 S | 30 mm | G 1 1/4" |
| 6610-38-24 | WHB 38 S | 38 mm | G 1 1/2" |



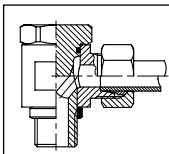

**6111/6611**

**WHB-M**  
Banjo - M Utv.  
Genomgående bult  
Skärkantring, strypfri  
PRODUKTGRUPP 600

| Artikelnr. | Typ      | Rördim. | Gänga     |
|------------|----------|---------|-----------|
| 6111-06-10 | WHB 6 L  | 6 mm    | M10 x 1,0 |
| 6111-08-12 | WHB 8 L  | 8 mm    | M12 x 1,5 |
| 6111-10-14 | WHB 10 L | 10 mm   | M14 x 1,5 |
| 6111-12-16 | WHB 12 L | 12 mm   | M16 x 1,5 |
| 6111-15-18 | WHB 15 L | 15 mm   | M18 x 1,5 |
| 6111-18-22 | WHB 18 L | 18 mm   | M22 x 1,5 |
| 6111-22-26 | WHB 22 L | 22 mm   | M26 x 1,5 |
| 6111-28-33 | WHB 28 L | 28 mm   | M33 x 2,0 |
| 6111-35-42 | WHB 35 L | 35 mm   | M42 x 2,0 |
| 6111-42-48 | WHB 42 L | 42 mm   | M48 x 2,0 |
| 6611-06-12 | WHB 6 S  | 6 mm    | M12 x 1,5 |
| 6611-08-14 | WHB 8 S  | 8 mm    | M14 x 1,5 |
| 6611-10-16 | WHB 10 S | 10 mm   | M16 x 1,5 |
| 6611-12-18 | WHB 12 S | 12 mm   | M18 x 1,5 |
| 6611-16-22 | WHB 16 S | 16 mm   | M22 x 1,5 |
| 6611-20-27 | WHB 20 S | 20 mm   | M27 x 2,0 |
| 6611-25-33 | WHB 25 S | 25 mm   | M33 x 2,0 |
| 6611-30-42 | WHB 30 S | 30 mm   | M42 x 2,0 |
| 6611-38-48 | WHB 38 S | 38 mm   | M48 x 2,0 |

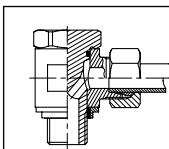

**6119/6619**

**WHO - M**  
Banjo - M Utv.  
Genomgående bult  
Mjuktätning teflon, strypfri  
PRODUKTGRUPP 600

| Artikelnr. | Typ      | Rördim. | Gänga     |
|------------|----------|---------|-----------|
| 6119-06-10 | WHO 6 L  | 6 mm    | M10 x 1,0 |
| 6119-08-12 | WHO 8 L  | 8 mm    | M12 x 1,5 |
| 6119-10-14 | WHO 10 L | 10 mm   | M14 x 1,5 |
| 6119-12-16 | WHO 12 L | 12 mm   | M16 x 1,5 |
| 6119-15-18 | WHO 15 L | 15 mm   | M18 x 1,5 |
| 6119-18-22 | WHO 18 L | 18 mm   | M22 x 1,5 |
| 6119-22-26 | WHO 22 L | 22 mm   | M26 x 1,5 |
| 6619-06-12 | WHO 6 S  | 6 mm    | M12 x 1,5 |
| 6619-08-14 | WHO 8 S  | 8 mm    | M14 x 1,5 |
| 6619-10-16 | WHO 10 S | 10 mm   | M16 x 1,5 |
| 6619-12-18 | WHO 12 S | 12 mm   | M18 x 1,5 |
| 6619-14-20 | WHO 14 S | 14 mm   | M20 x 1,5 |
| 6619-16-22 | WHO 16 S | 16 mm   | M22 x 1,5 |
| 6619-20-27 | WHO 20 S | 20 mm   | M27 x 2,0 |

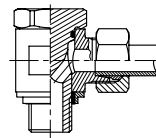

**6118/6618**

**WHO - G**  
Banjo - G utv. genomgående bult  
Komplett  
Mjuktätning teflon, strypfri  
PRODUKTGRUPP 600

| Artikelnr. | Typ      | Rördim. | Gänga    |
|------------|----------|---------|----------|
| 6118-06-02 | WHO 6 L  | 6 mm    | G 1/8"   |
| 6118-08-04 | WHO 8 L  | 8 mm    | G 1/4"   |
| 6118-10-04 | WHO 10 L | 10 mm   | G 1/4"   |
| 6118-12-06 | WHO 12 L | 12 mm   | G 3/8"   |
| 6118-15-08 | WHO 15 L | 15 mm   | G 1/2"   |
| 6118-18-08 | WHO 18 L | 18 mm   | G 1/2"   |
| 6118-22-12 | WHO 22 L | 22 mm   | G 3/4"   |
| 6618-06-04 | WHO 6 S  | 6 mm    | G 1/4"   |
| 6618-08-04 | WHO 8 S  | 8 mm    | G 1/4"   |
| 6618-10-06 | WHO 10 S | 10 mm   | G 3/8"   |
| 6618-12-06 | WHO 12 S | 12 mm   | G 3/8"   |
| 6618-14-08 | WHO 14 S | 14 mm   | G 1/2"   |
| 6618-16-08 | WHO 16 S | 16 mm   | G 1/2"   |
| 6618-25-16 | WHO 25 S | 25 mm   | G 1"     |
| 6618-30-20 | WHO 30 S | 30 mm   | G 1 1/4" |

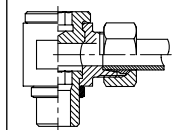

**6112/6612**

**DSVW - G**  
Banjo - M Utv.  
Delad bult  
Skärkantring, strypfri  
PRODUKTGRUPP 600

| Artikelnr. | Typ       | Rördim. | Gänga    |
|------------|-----------|---------|----------|
| 6112-06-02 | DSVW 6 L  | 6 mm    | G 1/8"   |
| 6112-08-04 | DSVW 8 L  | 8 mm    | G 1/4"   |
| 6112-10-04 | DSVW 10 L | 10 mm   | G 1/4"   |
| 6112-12-06 | DSVW 12 L | 12 mm   | G 3/8"   |
| 6112-15-08 | DSVW 15 L | 15 mm   | G 1/2"   |
| 6112-18-08 | DSVW 18 L | 18 mm   | G 1/2"   |
| 6112-22-12 | DSVW 22 L | 22 mm   | G 3/4"   |
| 6112-28-16 | DSVW 28 L | 28 mm   | G 1"     |
| 6112-35-20 | DSVW 35 L | 35 mm   | G 1 1/4" |
| 6112-42-24 | DSVW 42 L | 42 mm   | G 1 1/2" |
| 6612-06-04 | DSVW 6 S  | 6 mm    | G 1/4"   |
| 6612-08-04 | DSVW 8 S  | 8 mm    | G 1/4"   |
| 6612-10-06 | DSVW 10 S | 10 mm   | G 3/8"   |
| 6612-12-06 | DSVW 12 S | 12 mm   | G 3/8"   |
| 6612-14-08 | DSVW 14 S | 14 mm   | G 1/2"   |
| 6612-16-08 | DSVW 16 S | 16 mm   | G 1/2"   |
| 6612-20-12 | DSVW 20 S | 20 mm   | G 3/4"   |
| 6612-25-16 | DSVW 25 S | 25 mm   | G 1"     |



**6116/6616**

**WHBT – G**

Banjo T – G utv. genomgående bult  
Komplett  
Skärkantring, strypfri  
PRODUKTGRUPP 600

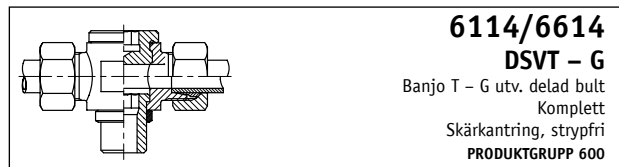

**6114/6614**

**DSVT – G**

Banjo T – G utv. delad bult  
Komplett  
Skärkantring, strypfri  
PRODUKTGRUPP 600

| Artikelnr. | Typ       | Rördim. | Gänga  |
|------------|-----------|---------|--------|
| 6116-06-02 | WHBT 6 L  | 6 mm    | 1/8"   |
| 6116-08-04 | WHBT 8 L  | 8 mm    | 1/4"   |
| 6116-10-04 | WHBT 10 L | 10 mm   | 1/4"   |
| 6116-12-06 | WHBT 12 L | 12 mm   | 3/4"   |
| 6116-15-08 | WHBT 15 L | 15 mm   | 1/2"   |
| 6116-18-08 | WHBT 18 L | 18 mm   | 1/2"   |
| 6116-22-12 | WHBT 22 L | 22 mm   | 3/4"   |
| 6116-28-16 | WHBT 28 L | 28 mm   | 1"     |
| 6116-35-20 | WHBT 35 L | 35 mm   | 1 1/4" |
| 6116-42-24 | WHBT 42 L | 42 mm   | 1 1/2" |
| 6616-06-04 | WHBT 6 S  | 6 mm    | 1/4"   |
| 6616-08-04 | WHBT 8 S  | 8 mm    | 1/4"   |
| 6616-10-06 | WHBT 10 S | 10 mm   | 3/8"   |
| 6616-12-06 | WHBT 12 S | 12 mm   | 3/8"   |
| 6616-14-08 | WHBT 14 S | 14 mm   | 1/2"   |
| 6616-16-08 | WHBT 16 S | 16 mm   | 1/2"   |
| 6616-20-12 | WHBT 20 S | 20 mm   | 3/4"   |
| 6616-25-16 | WHBT 25 S | 25 mm   | 1"     |
| 6616-30-20 | WHBT 30 S | 30 mm   | 1 1/4" |
| 6616-38-24 | WHBT 38 S | 38 mm   | 1 1/2" |

| Artikelnr. | Typ       | Rördim. | Gänga  |
|------------|-----------|---------|--------|
| 6114-06-02 | DSVT 6 L  | 6 mm    | 1/8"   |
| 6114-08-04 | DSVT 8 L  | 8 mm    | 1/4"   |
| 6114-10-04 | DSVT 10 L | 10 mm   | 1/4"   |
| 6114-12-06 | DSVT 12 L | 12 mm   | 3/8"   |
| 6114-15-08 | DSVT 15 L | 15 mm   | 1/2"   |
| 6114-18-08 | DSVT 18 L | 18 mm   | 1/2"   |
| 6114-22-12 | DSVT 22 L | 22 mm   | 3/4"   |
| 6114-28-16 | DSVT 28 L | 28 mm   | 1"     |
| 6114-35-20 | DSVT 35 L | 35 mm   | 1 1/4" |
| 6114-42-24 | DSVT 42 L | 42 mm   | 1 1/4" |
| 6614-06-04 | DSVT 6 S  | 6 mm    | 1/4"   |
| 6614-08-04 | DSVT 8 S  | 8 mm    | 1/4"   |
| 6614-10-06 | DSVT 10 S | 10 mm   | 3/8"   |
| 6614-12-06 | DSVT 12 S | 12 mm   | 3/8"   |
| 6614-14-08 | DSVT 14 S | 14 mm   | 1/2"   |
| 6614-16-08 | DSVT 16 S | 16 mm   | 1/2"   |
| 6614-20-12 | DSVT 20 S | 20 mm   | 3/4"   |
| 6614-25-16 | DSVT 25 S | 25 mm   | 1"     |
| 6614-30-20 | DSVT 30 S | 30 mm   | 1 1/4" |
| 6614-38-24 | DSVT 38 S | 38 mm   | 1 1/2" |

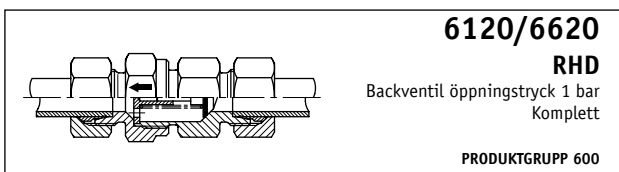

**6120/6620**

**RHD**

Backventil öppningstryck 1 bar  
Komplett

PRODUKTGRUPP 600

| Artikelnr. | Typ      | Rördim. |
|------------|----------|---------|
| 6120-06-06 | RHD 6 L  | 6 mm    |
| 6120-08-08 | RHD 8 L  | 8 mm    |
| 6120-10-10 | RHD 10 L | 10 mm   |
| 6120-12-12 | RHD 12 L | 12 mm   |
| 6120-15-15 | RHD 15 L | 15 mm   |
| 6120-18-18 | RHD 18 L | 18 mm   |
| 6120-22-22 | RHD 22 L | 22 mm   |
| 6120-28-28 | RHD 28 L | 28 mm   |
| 6120-35-35 | RHD 35 L | 35 mm   |
| 6120-42-42 | RHD 42 L | 42 mm   |
| 6620-06-06 | RHD 6 S  | 6 mm    |
| 6620-08-08 | RHD 8 S  | 8 mm    |
| 6620-10-10 | RHD 10 S | 10 mm   |
| 6620-12-12 | RHD 12 S | 12 mm   |
| 6620-14-14 | RHD 14 S | 14 mm   |
| 6620-16-16 | RHD 16 S | 16 mm   |
| 6620-20-20 | RHD 20 S | 20 mm   |
| 6620-25-25 | RHD 25 S | 25 mm   |
| 6620-30-30 | RHD 30 S | 30 mm   |
| 6620-38-38 | RHD 38 S | 38 mm   |

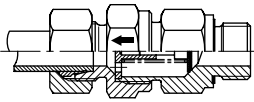

**6121/6621**

**RHV – G**

Backventil öppningstryck 1 bar  
Komplett  
ED-tätning  
PRODUKTGRUPP 600

| Artikelnr. | Typ      | Rördim. | Gänga    |
|------------|----------|---------|----------|
| 6121-06-02 | RHV 6 L  | 6 mm    | G 1/8"   |
| 6121-08-04 | RHV 8 L  | 8 mm    | G 1/4"   |
| 6121-10-04 | RHV 10 L | 10 mm   | G 1/4"   |
| 6121-12-06 | RHV 12 L | 12 mm   | G 3/8"   |
| 6121-15-08 | RHV 15 L | 15 mm   | G 1/2"   |
| 6121-18-08 | RHV 18 L | 18 mm   | G 1/2"   |
| 6121-22-12 | RHV 22 L | 22 mm   | G 3/4"   |
| 6121-28-16 | RHV 28 L | 28 mm   | G 1"     |
| 6121-35-20 | RHV 35 L | 35 mm   | G 1 1/4" |
| 6121-42-24 | RHV 42 L | 42 mm   | G 1 1/2" |
|            |          |         |          |
| 6621-06-04 | RHV 6 S  | 6 mm    | G 1/4"   |
| 6621-08-04 | RHV 8 S  | 8 mm    | G 1/4"   |
| 6621-10-06 | RHV 10 S | 10 mm   | G 3/8"   |
| 6621-12-06 | RHV 12 S | 12 mm   | G 3/8"   |
| 6621-14-08 | RHV 14 S | 14 mm   | G 1/2"   |
| 6621-16-08 | RHV 16 S | 16 mm   | G 1/2"   |
| 6621-20-12 | RHV 20 S | 20 mm   | G 3/4"   |
| 6621-25-16 | RHV 25 S | 25 mm   | G 1"     |
| 6621-30-20 | RHV 30 S | 30 mm   | G 1 1/4" |
| 6621-38-24 | RHV 38 S | 38 mm   | G 1 1/2" |

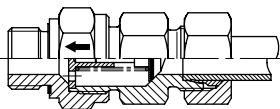

**6123/6623**

**RHZ – G – ED**

Backventil öppningstryck 1 bar  
Komplett  
PRODUKTGRUPP 600

| Artikelnr. | Typ      | Rördim. | Gänga    |
|------------|----------|---------|----------|
| 6123-06-02 | RHZ 6 L  | 6 mm    | G 1/8"   |
| 6123-08-04 | RHZ 8 L  | 8 mm    | G 1/4"   |
| 6123-10-04 | RHZ 10 L | 10 mm   | G 1/4"   |
| 6123-12-06 | RHZ 12 L | 12 mm   | G 3/8"   |
| 6123-15-08 | RHZ 15 L | 15 mm   | G 1/2"   |
| 6123-18-08 | RHZ 18 L | 18 mm   | G 1/2"   |
| 6123-22-12 | RHZ 22 L | 22 mm   | G 3/4"   |
| 6123-28-16 | RHZ 28 L | 28 mm   | G 1"     |
| 6123-35-20 | RHZ 35 L | 35 mm   | G 1 1/4" |
| 6123-42-24 | RHZ 42 L | 42 mm   | G 1 1/2" |
|            |          |         |          |
| 6623-06-04 | RHZ 6 S  | 6 mm    | G 1/4"   |
| 6623-08-04 | RHZ 8 S  | 8 mm    | G 1/4"   |
| 6623-10-06 | RHZ 10 S | 10 mm   | G 3/8"   |
| 6623-12-06 | RHZ 12 S | 12 mm   | G 3/8"   |
| 6623-14-08 | RHZ 14 S | 14 mm   | G 1/2"   |
| 6623-16-08 | RHZ 16 S | 16 mm   | G 1/2"   |
| 6623-20-12 | RHZ 20 S | 20 mm   | G 3/4"   |
| 6623-25-16 | RHZ 25 S | 25 mm   | G 1"     |
| 6623-30-20 | RHZ 30 S | 30 mm   | G 1 1/4" |
| 6623-38-24 | RHZ 38 S | 38 mm   | G 1 1/2" |

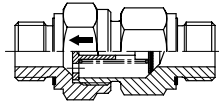

**6126**

**RHR**

Backventil öppningstryck 1 bar  
Komplett  
ED-tätning  
PRODUKTGRUPP 600

| Artikelnr. | Typ | Gänga     |
|------------|-----|-----------|
| 6126-04-04 | RHR | G 1/4" UF |
| 6126-06-06 | RHR | G 3/8" UF |
| 6126-08-08 | RHR | G 1/2" UF |
| 6126-12-12 | RHR | G 3/4" UF |
| 6126-16-16 | RHR | G 1" UF   |

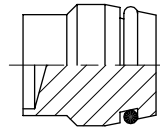

**6130/6630**

**PL**  
Plugg

PRODUKTGRUPP 600

| Artikelnr. | Typ       | Rördim. |
|------------|-----------|---------|
| 6130-00-06 | PL 6 L/S  | 6 mm    |
| 6130-00-08 | PL 8 L/S  | 8 mm    |
| 6130-00-10 | PL 10 L/S | 10 mm   |
| 6130-00-12 | PL 12 L/S | 12 mm   |
| 6130-00-15 | PL 15 L   | 15 mm   |
| 6130-00-18 | PL 18 L   | 18 mm   |
| 6130-00-22 | PL 22 L   | 22 mm   |
| 6130-00-28 | PL 28 L   | 28 mm   |
| 6130-00-35 | PL 35 L   | 35 mm   |
| 6130-00-42 | PL 42 L   | 42 mm   |
|            |           |         |
| 6630-00-14 | PL 14 S   | 14 mm   |
| 6630-00-16 | PL 16 S   | 16 mm   |
| 6630-00-20 | PL 20 S   | 20 mm   |
| 6630-00-25 | PL 25 S   | 25 mm   |
| 6630-00-30 | PL 30 S   | 30 mm   |
| 6630-00-38 | PL 38 S   | 38 mm   |

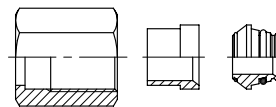

**6131/6631**

**Adaptersats**

För skäringskoppling till  
kragskoppling 37° kona

PRODUKTGRUPP 600

| Artikelnr. | Typ      | Rördim. |
|------------|----------|---------|
| 6131-00-06 | HOA 6 L  | 6 mm    |
| 6131-00-08 | HOA 8 L  | 8 mm    |
| 6131-00-10 | HOA 10 L | 10 mm   |
| 6131-00-12 | HOA 12 L | 12 mm   |
| 6131-00-15 | HOA 15 L | 15 mm   |
| 6131-00-18 | HOA 18 L | 18 mm   |
| 6131-00-22 | HOA 22 L | 22 mm   |
| 6131-00-28 | HOA 28 L | 28 mm   |
| 6131-00-35 | HOA 35 L | 35 mm   |
| 6131-00-42 | HOA 42 L | 42 mm   |
|            |          |         |
| 6631-00-06 | HOA 6 S  | 6 mm    |
| 6631-00-08 | HOA 8 S  | 8 mm    |
| 6631-00-10 | HOA 10 S | 10 mm   |
| 6631-00-12 | HOA 12 S | 12 mm   |
| 6631-00-14 | HOA 14 S | 14 mm   |
| 6631-00-16 | HOA 16 S | 16 mm   |
| 6631-00-20 | HOA 20 S | 20 mm   |
| 6631-00-25 | HOA 25 S | 25 mm   |
| 6631-00-30 | HOA 30 S | 30 mm   |
| 6631-00-38 | HOA 38 S | 38 mm   |

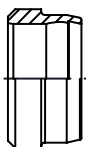

**6149/6649**

**D**  
Skärring

PRODUKTGRUPP 600

| Artikelnr. | Typ      | Rördim. |
|------------|----------|---------|
| 6149-01-06 | D 6 L/S  | 6 mm    |
| 6149-01-08 | D 8 L/S  | 8 mm    |
| 6149-01-10 | D 10 L/S | 10 mm   |
| 6149-01-12 | D 12 L/S | 12 mm   |
| 6149-01-15 | D 15 L   | 15 mm   |
| 6149-01-18 | D 18 L   | 18 mm   |
| 6149-01-22 | D 22 L   | 22 mm   |
| 6149-01-28 | D 28 L   | 28 mm   |
| 6149-01-35 | D 35 L   | 35 mm   |
| 6149-01-42 | D 42 L   | 42 mm   |
| 6649-01-14 | D 14 S   | 14 mm   |
| 6649-01-16 | D 16 S   | 16 mm   |
| 6649-01-20 | D 20 S   | 20 mm   |
| 6649-01-25 | D 25 S   | 25 mm   |
| 6649-01-30 | D 30 S   | 30 mm   |
| 6649-01-38 | D 38 S   | 38 mm   |

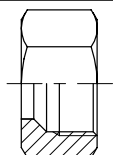

**6150/6650**

**M**  
Mutter

PRODUKTGRUPP 600

| Artikelnr. | Typ    | Rördim. | Gänga      |
|------------|--------|---------|------------|
| 6150-00-06 | M 6 L  | 6 mm    | M 12 x 1.5 |
| 6150-00-08 | M 8 L  | 8 mm    | M 14 x 1.5 |
| 6150-00-10 | M 10 L | 10 mm   | M 16 x 1.5 |
| 6150-00-12 | M 12 L | 12 mm   | M 18 x 1.5 |
| 6150-00-15 | M 15 L | 15 mm   | M 22 x 1.5 |
| 6150-00-18 | M 18 L | 18 mm   | M 26 x 1.5 |
| 6150-00-22 | M 22 L | 22 mm   | M 30 x 2.0 |
| 6150-00-28 | M 28 L | 28 mm   | M 36 x 2.0 |
| 6150-00-35 | M 35 L | 35 mm   | M 45 x 2.0 |
| 6150-00-42 | M 42 L | 42 mm   | M 52 x 2.0 |
| 6650-00-06 | M 6 S  | 6 mm    | M 14 x 1.5 |
| 6650-00-08 | M 8 S  | 8 mm    | M 16 x 1.5 |
| 6650-00-10 | M 10 S | 10 mm   | M 18 x 1.5 |
| 6650-00-12 | M 12 S | 12 mm   | M 20 x 1.5 |
| 6650-00-14 | M 14 S | 14 mm   | M 22 x 1.5 |
| 6650-00-16 | M 16 S | 16 mm   | M 24 x 1.5 |
| 6650-00-20 | M 20 S | 20 mm   | M 30 x 2.0 |
| 6650-00-25 | M 25 S | 25 mm   | M 36 x 2.0 |
| 6650-00-30 | M 30 S | 30 mm   | M 42 x 2.0 |
| 6650-00-38 | M 38 S | 38 mm   | M 52 x 2.0 |

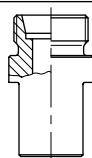

**6151/6651**

**FM**  
Förmonteringsdorn

PRODUKTGRUPP 900

| Artikelnr. | Typ     | Rördim. |
|------------|---------|---------|
| 6151-00-06 | FM 6 L  | 6 mm    |
| 6151-00-08 | FM 8 L  | 8 mm    |
| 6151-00-10 | FM 10 L | 10 mm   |
| 6151-00-12 | FM 12 L | 12 mm   |
| 6151-00-15 | FM 15 L | 15 mm   |
| 6151-00-18 | FM 18 L | 18 mm   |
| 6151-00-22 | FM 22 L | 22 mm   |
| 6151-00-28 | FM 28 L | 28 mm   |
| 6151-00-35 | FM 35 L | 35 mm   |
| 6151-00-42 | FM 42 L | 42 mm   |
| 6651-00-06 | FM 6 S  | 6 mm    |
| 6651-00-08 | FM 8 S  | 8 mm    |
| 6651-00-10 | FM 10 S | 10 mm   |
| 6651-00-12 | FM 12 S | 12 mm   |
| 6651-00-14 | FM 14 S | 14 mm   |
| 6651-00-16 | FM 16 S | 16 mm   |
| 6651-00-20 | FM 20 S | 20 mm   |
| 6651-00-25 | FM 25 S | 25 mm   |
| 6651-00-30 | FM 30 S | 30 mm   |
| 6651-00-38 | FM 38 S | 38 mm   |

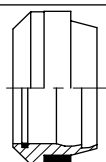

**6152/6652**

**D-ED B4**

Skärring och mjuktätning för mutter

PRODUKTGRUPP 600

| Artikelnr. | Typ            | Rördim. |
|------------|----------------|---------|
| 6152-03-06 | D - ED B4 6 L  | 6 mm    |
| 6152-03-08 | D - ED B4 8 L  | 8 mm    |
| 6152-03-10 | D - ED B4 10 L | 10 mm   |
| 6152-03-12 | D - ED B4 12 L | 12 mm   |
| 6152-03-15 | D - ED B4 15 L | 15 mm   |
| 6152-03-18 | D - ED B4 18 L | 18 mm   |
| 6152-03-22 | D - ED B4 22 L | 22 mm   |
| 6152-03-28 | D - ED B4 28 L | 28 mm   |
| 6152-03-35 | D - ED B4 35 L | 35 mm   |
| 6152-03-42 | D - ED B4 42 L | 42 mm   |
| 6652-03-06 | D - ED B4 6 S  | 6 mm    |
| 6652-03-08 | D - ED B4 8 S  | 8 mm    |
| 6652-03-10 | D - ED B4 10 S | 10 mm   |
| 6652-03-12 | D - ED B4 12 S | 12 mm   |
| 6652-03-14 | D - ED B4 14 S | 14 mm   |
| 6652-03-16 | D - ED B4 16 S | 16 mm   |
| 6652-03-20 | D - ED B4 20 S | 20 mm   |
| 6652-03-25 | D - ED B4 25 S | 25 mm   |
| 6652-03-30 | D - ED B4 30 S | 30 mm   |
| 6652-03-38 | D - ED B4 38 S | 38 mm   |







**6153**  
**GM – Låsmutter**  
För typ 6045/6046

PRODUKTGRUPP 600

| Artikelnr. | Typ       | Storlek   | Gänga      |
|------------|-----------|-----------|------------|
| 6153-00-12 | Låsmutter | 6 L       | M 12 x 1.5 |
| 6153-00-14 | Låsmutter | 8 L/6 S   | M 14 x 1.5 |
| 6153-00-16 | Låsmutter | 10 L/8 S  | M 16 x 1.5 |
| 6153-00-18 | Låsmutter | 12 L/10 S | M 18 x 1.5 |
| 6153-00-20 | Låsmutter | 12 S      | M 20 x 1.5 |
| 6153-00-22 | Låsmutter | 15 L/14 S | M 22 x 1.5 |
| 6153-00-24 | Låsmutter | 16 S      | M 24 x 1.5 |
| 6153-00-26 | Låsmutter | 18 S      | M 26 x 1.5 |
| 6153-00-30 | Låsmutter | 22 L/20 S | M 30 x 2.0 |
| 6153-00-36 | Låsmutter | 28 L/25 S | M 36 x 2.0 |
| 6153-00-42 | Låsmutter | 30 S      | M 42 x 2.0 |
| 6153-00-45 | Låsmutter | 35 S      | M 45 x 2.0 |
| 6153-00-52 | Låsmutter | 42 L/38 S | M 52 x 2.0 |

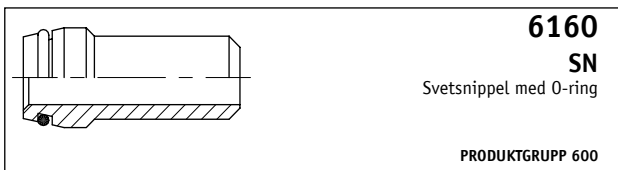

**6160**  
**SN**  
Svetsnippel med O-ring

PRODUKTGRUPP 600

| Artikelnr. | Typ   | Rördim. | Godstjocklek |
|------------|-------|---------|--------------|
| 6160-06-15 | SN 6  | 6 mm    | 1.75 mm      |
| 6160-08-15 | SN 8  | 8 mm    | 1.50 mm      |
| 6160-10-15 | SN 10 | 10 mm   | 1.50 mm      |
| 6160-10-20 | SN 10 | 10 mm   | 2.00 mm      |
| 6160-12-15 | SN 12 | 12 mm   | 1.50 mm      |
| 6160-12-20 | SN 12 | 12 mm   | 2.00 mm      |
| 6160-12-25 | SN 12 | 12 mm   | 2.50 mm      |
| 6160-16-20 | SN 16 | 16 mm   | 2.00 mm      |
| 6160-16-25 | SN 16 | 16 mm   | 2.50 mm      |
| 6160-16-30 | SN 16 | 16 mm   | 3.00 mm      |
| 6160-20-25 | SN 20 | 20 mm   | 2.50 mm      |
| 6160-20-30 | SN 20 | 20 mm   | 3.00 mm      |
| 6160-20-40 | SN 20 | 20 mm   | 4.00 mm      |
| 6160-22-25 | SN 22 | 22 mm   | 2.50 mm      |
| 6160-25-30 | SN 25 | 25 mm   | 3.00 mm      |
| 6160-25-40 | SN 25 | 25 mm   | 4.00 mm      |
| 6160-30-30 | SN 30 | 30 mm   | 3.00 mm      |
| 6160-30-40 | SN 30 | 30 mm   | 4.00 mm      |
| 6160-30-50 | SN 30 | 30 mm   | 5.00 mm      |
| 6160-38-40 | SN 38 | 38 mm   | 4.00 mm      |
| 6160-38-50 | SN 38 | 38 mm   | 5.00 mm      |
| 6160-42-30 | SN 42 | 42 mm   | 3.00 mm      |

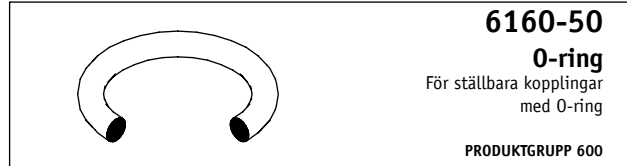

**6160-50**  
**O-ring**  
För ställbara kopplingar  
med O-ring

PRODUKTGRUPP 600

| Artikelnr. | Typ          | Rördim. |
|------------|--------------|---------|
| 6160-50-06 | O-ring SN 6  | 6 mm    |
| 6160-50-08 | O-ring SN 8  | 8 mm    |
| 6160-50-10 | O-ring SN 10 | 10 mm   |
| 6160-50-12 | O-ring SN 12 | 12 mm   |
| 6160-50-16 | O-ring SN 16 | 16 mm   |
| 6160-50-20 | O-ring SN 20 | 20 mm   |
| 6160-50-25 | O-ring SN 25 | 25 mm   |
| 6160-50-30 | O-ring SN 30 | 30 mm   |
| 6160-50-38 | O-ring SN 38 | 38 mm   |



**6154-00**  
**ED-tätning**  
NBR

PRODUKTGRUPP 600

| Artikelnr. | Typ         | Dim.   |
|------------|-------------|--------|
| 6154-00-02 | Tätning NBR | 1/8"   |
| 6154-00-04 | Tätning NBR | 1/4"   |
| 6154-00-06 | Tätning NBR | 3/8"   |
| 6154-00-08 | Tätning NBR | 1/2"   |
| 6154-00-12 | Tätning NBR | 3/4"   |
| 6154-00-16 | Tätning NBR | 1"     |
| 6154-00-20 | Tätning NBR | 1 1/4" |
| 6154-00-24 | Tätning NBR | 1 1/2" |

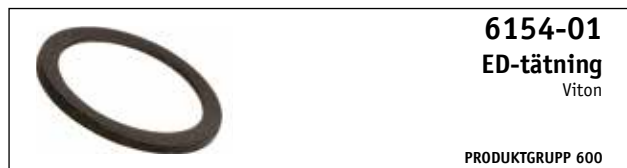

**6154-01**  
**ED-tätning**  
Viton

PRODUKTGRUPP 600

| Artikelnr. | Typ           | Dim.   |
|------------|---------------|--------|
| 6154-01-04 | Tätning Viton | 1/4"   |
| 6154-01-06 | Tätning Viton | 3/8"   |
| 6154-01-08 | Tätning Viton | 1/2"   |
| 6154-01-12 | Tätning Viton | 3/4"   |
| 6154-01-16 | Tätning Viton | 1"     |
| 6154-01-24 | Tätning Viton | 1 1/2" |



# SMOOTH CONNECTION MED KAPPAFLEX 2 CO SMOOTH

SLÄT YTTERTUB

KLARAR HÖGA TRYCK



[www.hydroscand.se](http://www.hydroscand.se)